

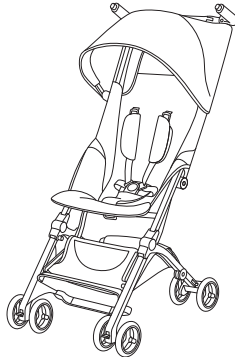













# POCKIT+ALL-TERRAIN

## FUTURE PERFECT



	POC KIT+ AL L-TERRAIN的整備步骤	7
	靠背调节方法	9
	日常用折叠	10
	紧凑折叠	12
	安全带使用方法	14
	刹车使用方法	17
	前轮万向、定向使用方法	18
	雨罩使用方法	19
	安全座提篮兼容方案	20
	布套拆卸方法	23/26
	睡篮 (COT TO GO) 兼容方案	24

	<b>PREPARING THE POKKIT+ ALL-TERRAIN</b>	<b>7</b>
	<b>ADJUSTING THE SEAT POSITION</b>	<b>9</b>
	<b>COMPACT FOLD</b>	<b>10</b>
	<b>ULTRA COMPACT FOLD</b>	<b>12</b>
	<b>USING THE HARNESS SYSTEM</b>	<b>14</b>
	<b>USING THE BRAKE</b>	<b>17</b>
	<b>USING THE SWIVEL LOCKS</b>	<b>18</b>
	<b>USING THE RAIN COVER</b>	<b>19</b>
	<b>ATTACHING THE INFANT CAR SEAT</b>	<b>20</b>
	<b>REMOVING THE FABRIC</b>	<b>23/26</b>
	<b>ATTACHING THE COT TO GO</b>	<b>24</b>

**VORBEREITUNG DES POCKIT+ ALL-TERRAIN****7****EINSTELLEN DER RÜCKENLEHNE****9****KOMPAKTE POSITION****10****ULTRA KOMPAKTE POSITION****12****VERWENDUNG DES GURTSYSTEMS****14****BENUTZUNG DER BREMSE****17****FESTSTELLEN DER VORDERRÄDER****18****VERWENDUNG DES REGENVERDECKS****19****ANBRINGEN DER BABYSCHALE****20****ABNEHMEN DER BEZÜGE****23/26****ANBRINGEN DES COT TO GO****24**

	<b>PREPARAR EL POCKIT+ ALL-TERRAIN</b>	<b>7</b>
	<b>AJUSTE DEL RESPALDO</b>	<b>9</b>
	<b>PLIEGUE COMPACTO</b>	<b>10</b>
	<b>PLIEGUE ULTRA COMPACTO</b>	<b>12</b>
	<b>USO DEL SISTEMA DE ARNESES</b>	<b>14</b>
	<b>USO DEL FRENO</b>	<b>17</b>
	<b>USO DEL BLOQUEO DE DIRECCIÓN DE LAS RUEDAS DELANTERAS</b>	<b>18</b>
	<b>USO DE LA BURBUJA DE LLUVIA</b>	<b>19</b>
	<b>COLOCACIÓN DEL ADAPTADOR DEL PORTABEBÉS</b>	<b>20</b>
	<b>RETIRAR LA VESTIDURA</b>	<b>23/26</b>
	<b>ADAPTACIÓN DEL COT TO GO</b>	<b>24</b>

	<b>PRÉPARATION DU POCKIT+ ALL-TERRAIN</b>	<b>7</b>
	<b>RÉGLAGE DU DOSSIER</b>	<b>9</b>
	<b>PLIAGE COMPACT</b>	<b>10</b>
	<b>PLIAGE ULTRA COMPACT</b>	<b>12</b>
	<b>UTILISATION DU HARNAIS</b>	<b>14</b>
	<b>UTILISATION DU FREIN</b>	<b>17</b>
	<b>UTILISATION DU VERROU DE ROTATION</b>	<b>18</b>
	<b>UTILISATION DE L'HABILLAGE PLUIE</b>	<b>19</b>
	<b>INSTALLATION DES ADAPTATEURS POUR COQUE</b>	<b>20</b>
	<b>RETIRER LA HOUSSE DU SIÈGE LUXE ATTACHER</b>	<b>23/26</b>
	<b>LA COT TO GO</b>	<b>24</b>

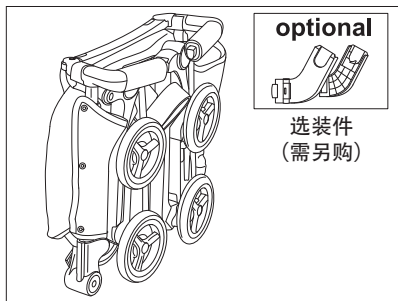

1

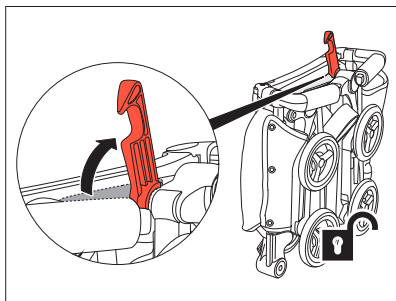

2

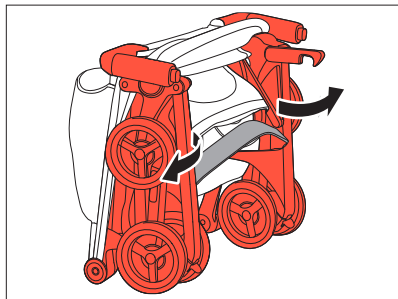

3

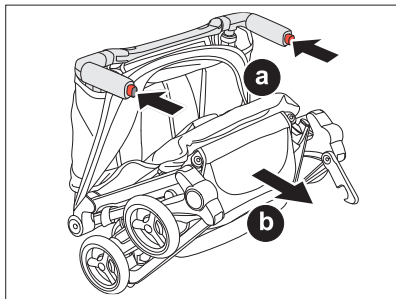

4

7



5

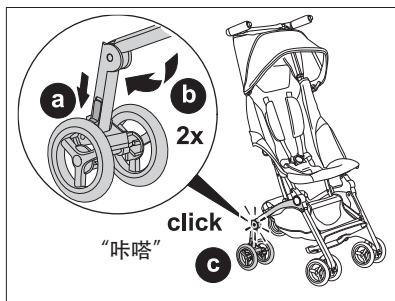

6





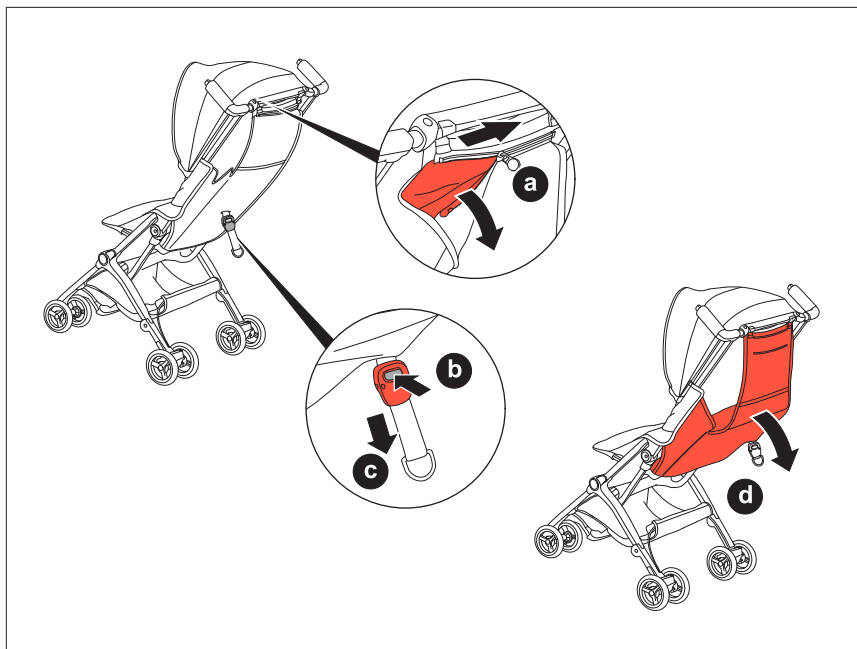

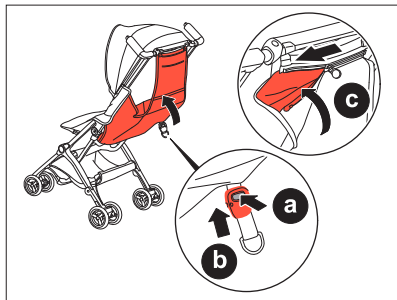
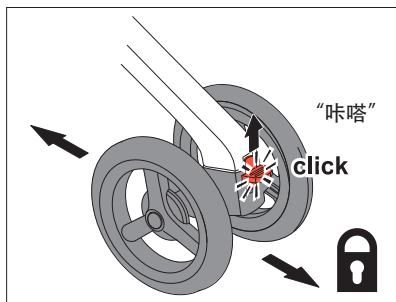
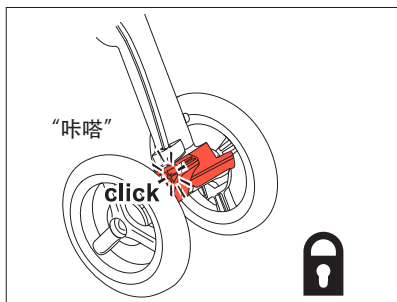

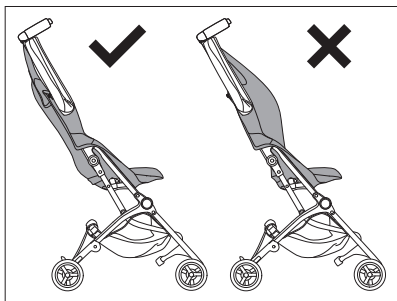

5

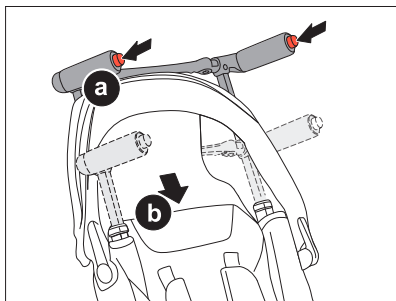

6

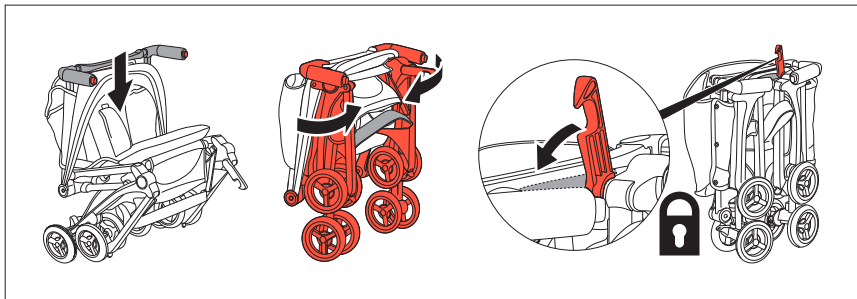

7

11

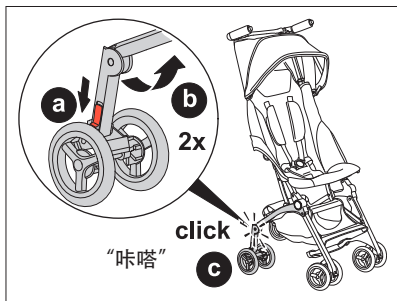

1

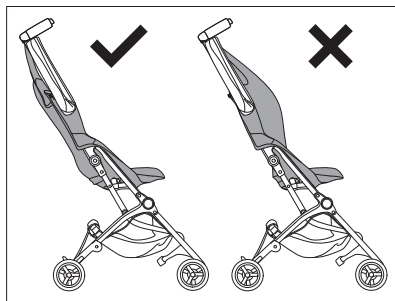

2

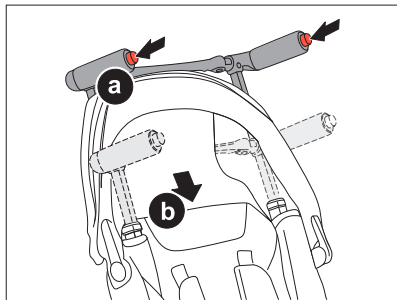

12 3

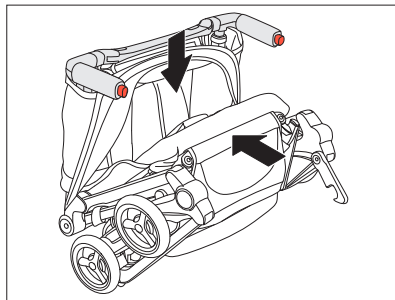

4

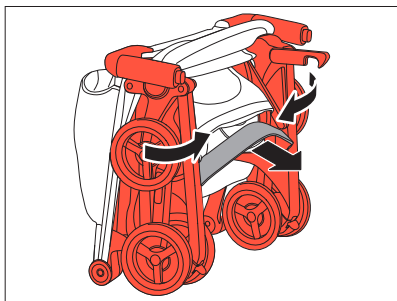

5

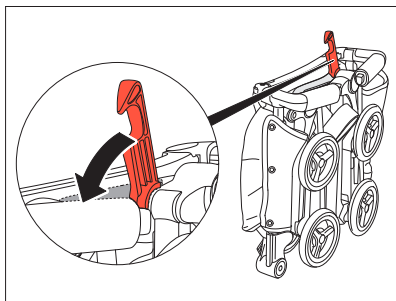

6

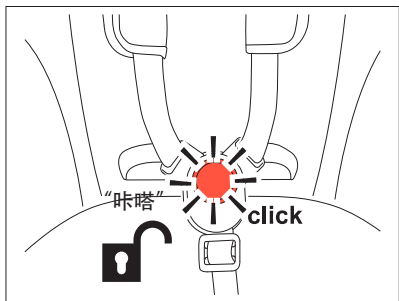

1

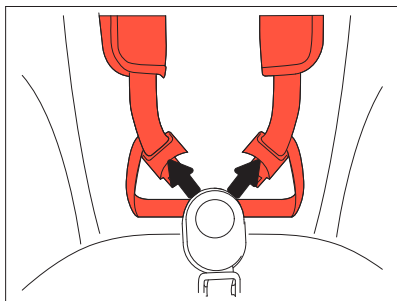

2

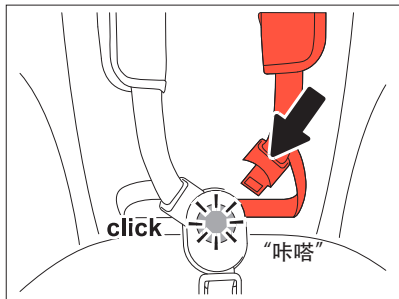

14 3

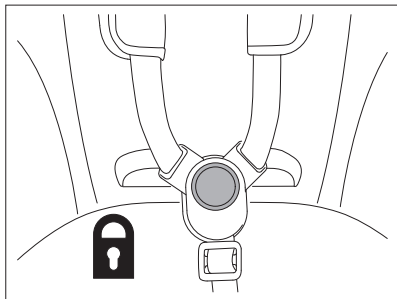

4



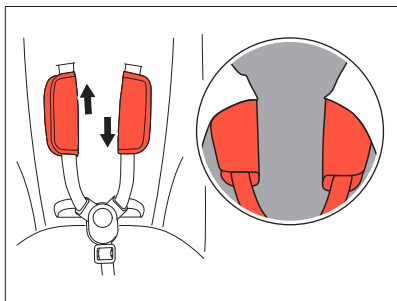

5

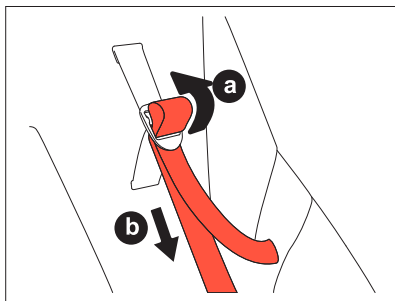

6

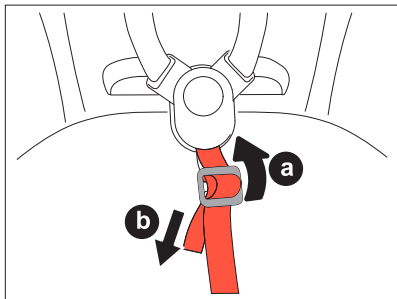

7

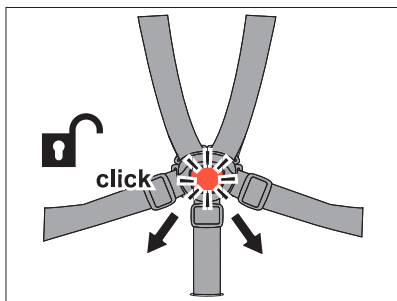

8

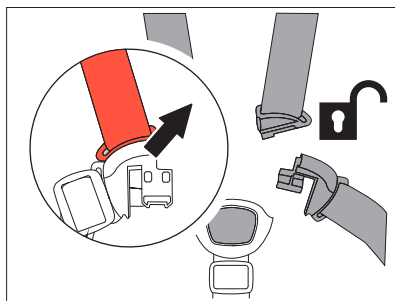

9

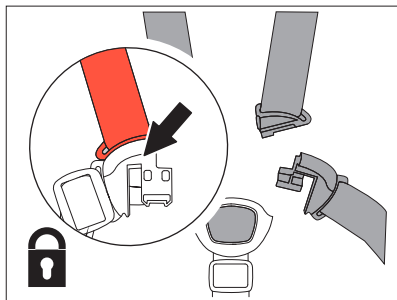

16 10

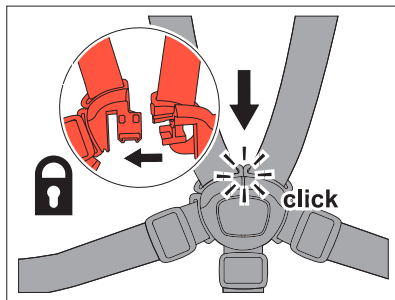

11





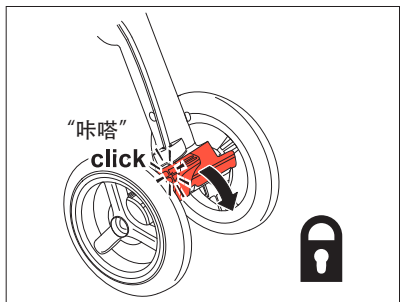

1

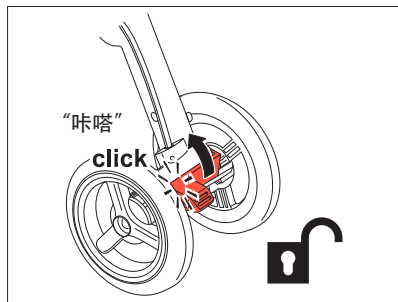

2

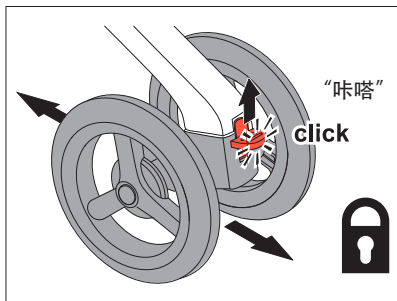

1

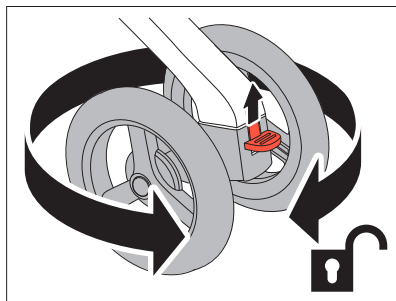

2



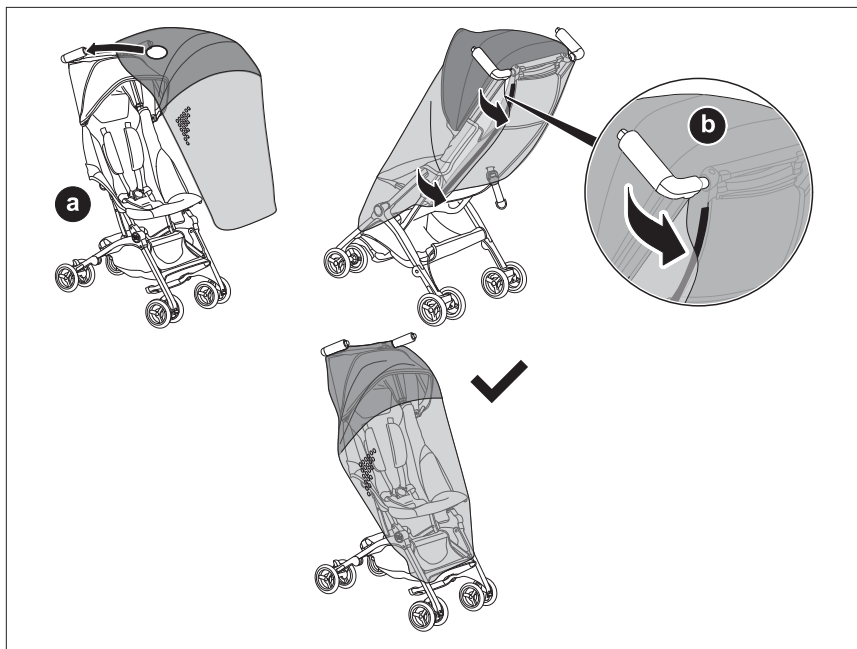

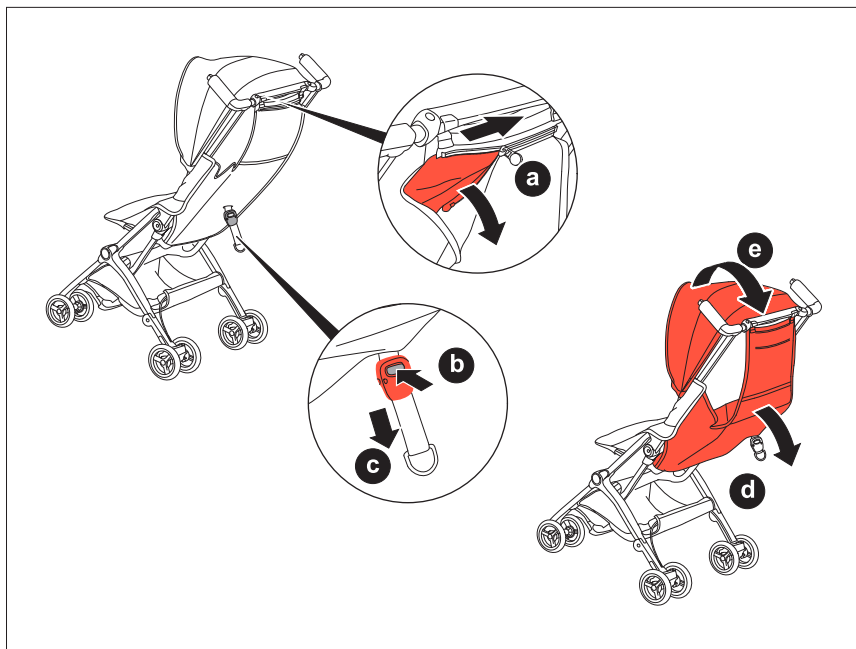

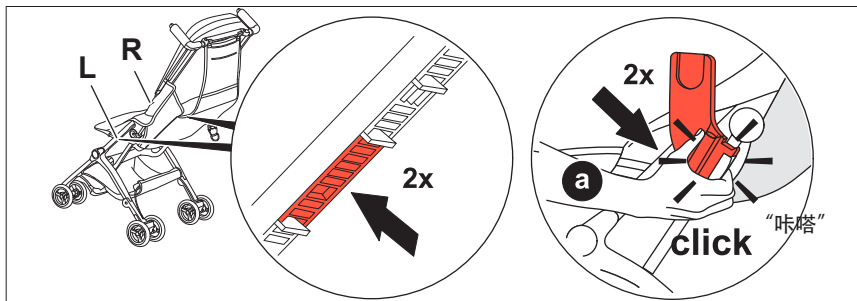

2



3

21

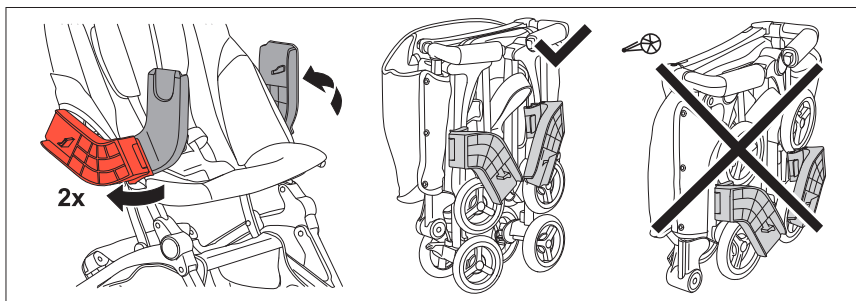

1

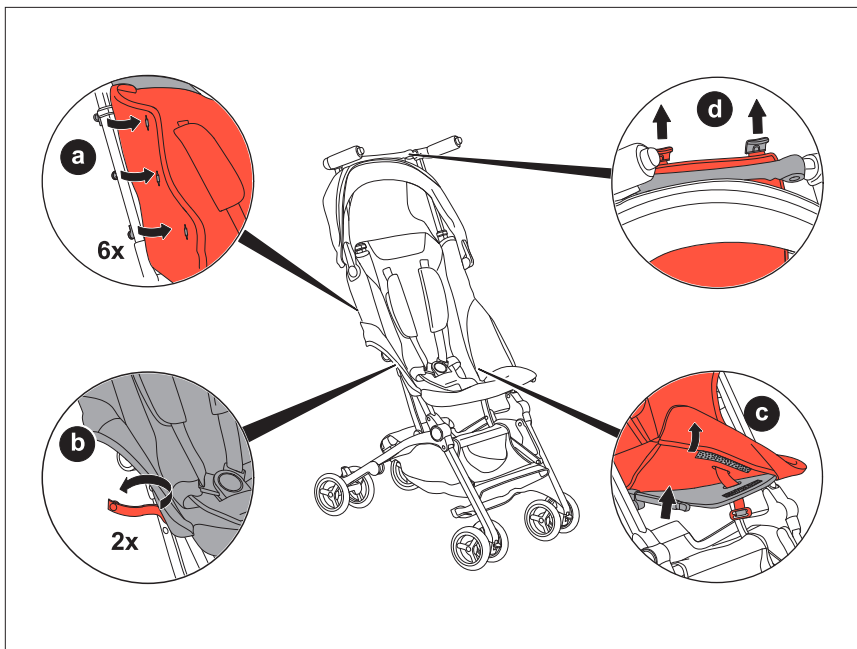

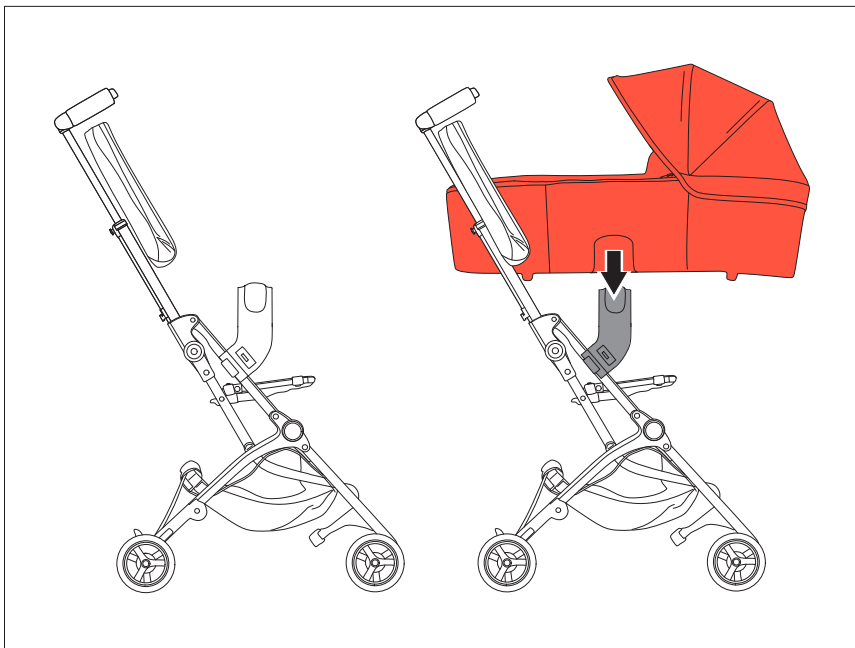



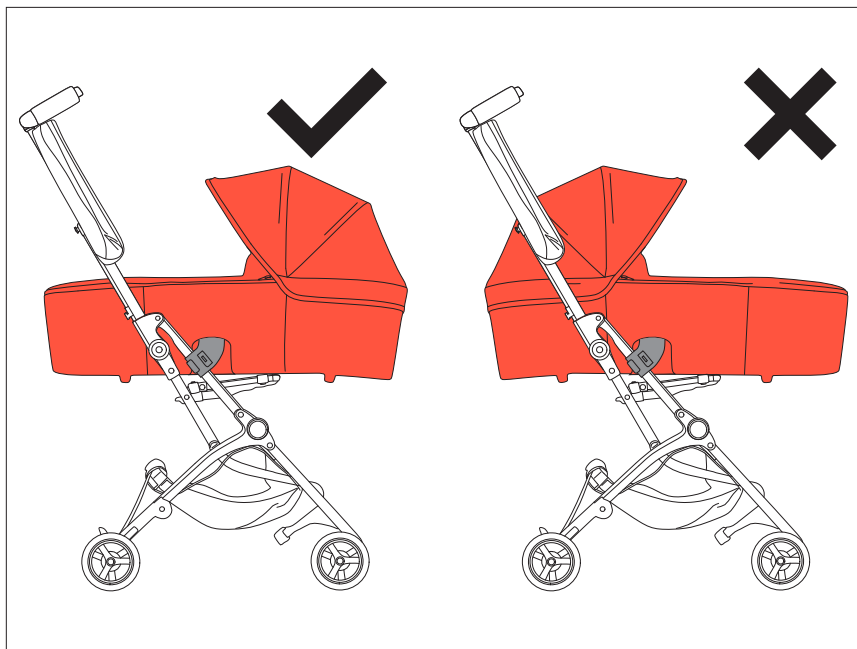

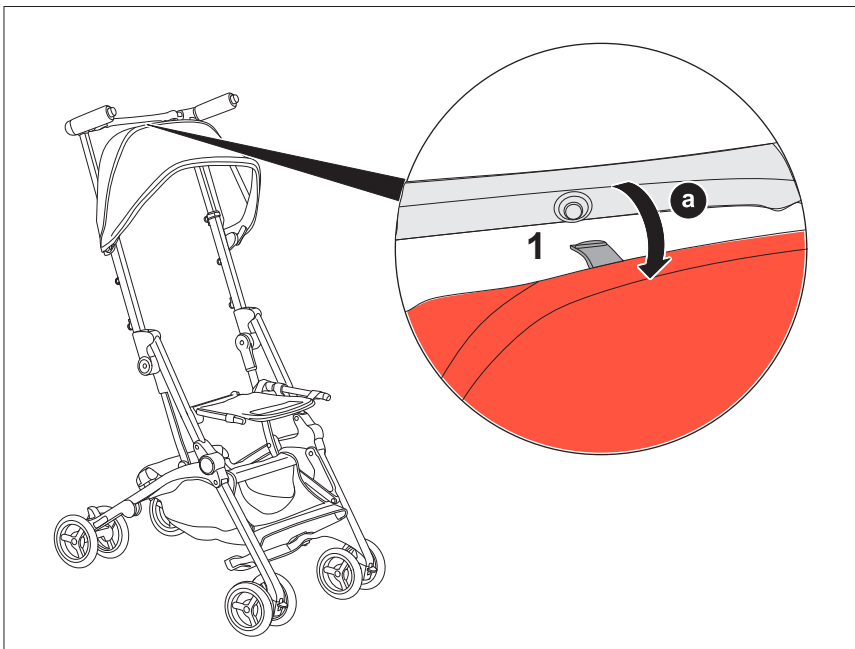

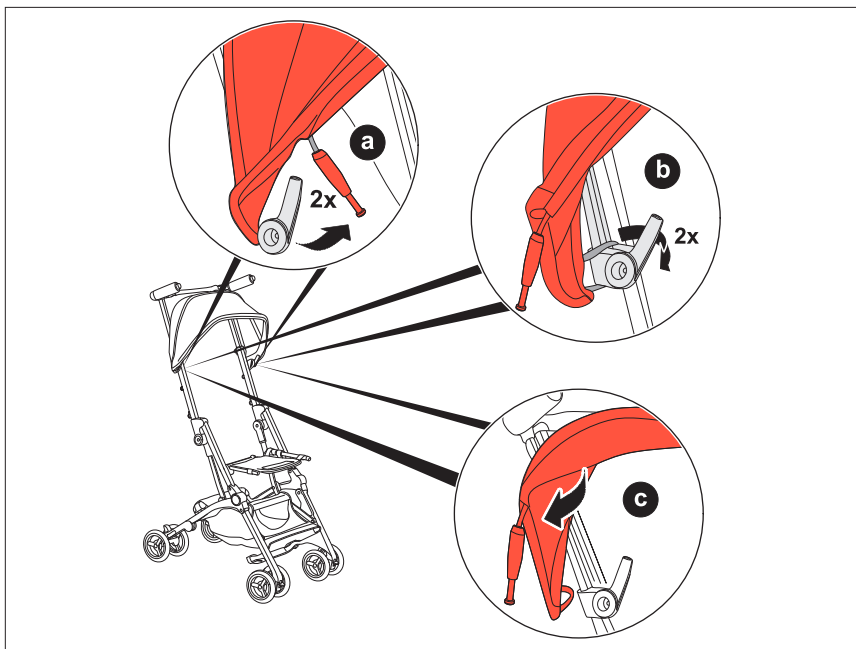

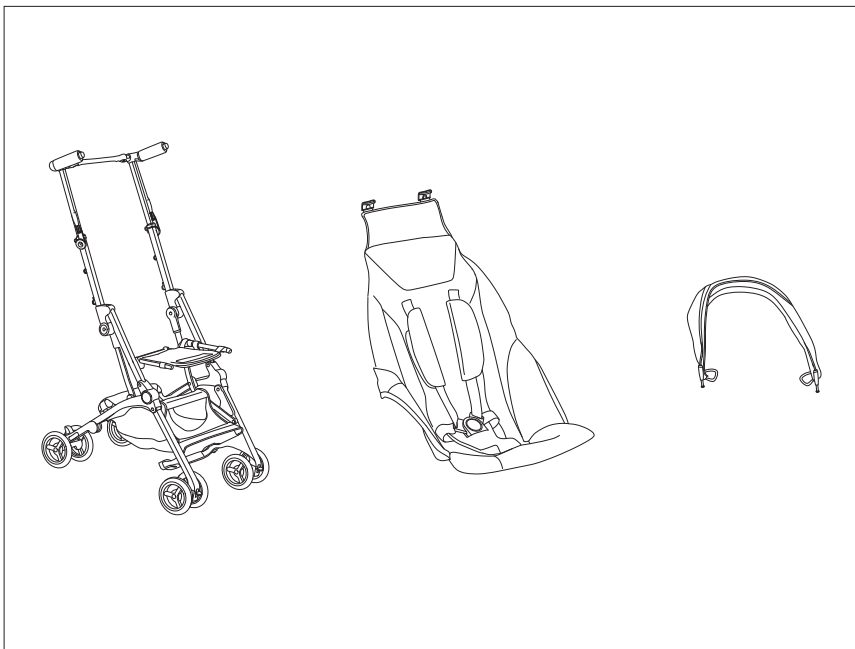



GOLD

**好孩子儿童用品有限公司**  
**地址：江苏昆山陆家镇陆丰东路28号**  
**产地：中国昆山**  
**邮编：215331**  
**全国24小时服务热线 400-828-0000**

Design by gb GmbH  
由德国gb GmbH设计  
地址：Riedinger Str.18| 95448  
Bayreuth| Germany

[www.gb-online.com](http://www.gb-online.com)



GOLD

---

## CONTACT

### EUROPE AND ASIA

gb GmbH  
Riedingerstr 18  
95448 Bayreuth  
Germany  
+49 (0) 921-78 511 - 0  
info@gb-online.com

### AMERICAS

Columbus Trading-Partners USA Inc.  
560 Harrison Avenue  
Suite 500  
Boston, MA 02118  
USA  
Customer Service 1-844-543-2020  
orders.us@columbustp.com

### AUSTRALIA

CNP Brands  
20 Calarco Drive, VIC, 3030  
Australia  
Customer Service 1300 667 137  
info@cnpbrands.com.au

### NEW ZEALAND

Wainhouse Distribution,  
2-6 Argyle St, Morningside,  
PO Box 41-014, St Lukes, Auckland  
New Zealand  
Customer Service: 0800 567 5000  
helpline@wainhousedist.co.nz