

 **cybex**
GOLD

LIBELLE





EN WARNING
DE WARNUNG
ES ADVERTENCIA
FR AVERTISSEMENT
PT AVISOS
IT WARNING
NL WAARSCHUWING
PL OSTRZEŻENIE
CS UPOZORNĚNÍ
SL OPOZORILO
HR UPOZORENJE
HU FIGYELMEZTETÉS
SE VARNING
NO ADVARSEL
FI VAROITUS
DA ADVARSEL
ET HOIATUS
LV BRĪDINĀJUMS
LT PERSPĖJIMAS
RU ВНИМАНИЕ
UK УВАГА
TR UYARI
EL ΠΡΟΕΙΔΟΠΟΙΗΣΗ
RO AVERTISMENTE
IS VIÐVÖRUN
MT TWISSIJA

AR
FA
YUE 警告
CMN 警告
JA 警告
KO 경고
BG ПРЕДУПРЕЖДЕНИЕ
SR UPOZORENJE
MS AMARAN
HI चेतावनी
TH คำเตือน
SQ PARALAJMËRIM
BS UPOZORENJE
ME UPOZORENJE
MK ПРЕДУПРЕДУВАЊЕ
HY ՉԳՈՒԴՇԱՅՈՒԴ
VI CẢNH BÁO

تحذير
اخطار



EN Tutorial video
DE Videoanleitung
ES Tutorial en vídeo
FR Vidéo de démonstration
PT Video tutorial
IT Video tutorial
NL Instructievideo
PL Film instruktażowy
CS Výchovné video
SL Video z navodili
HR Video s uputama
HU Bemutatóvideó
SE Videosjälvstudiekurs
NO Opplæringsvideo
FI Opetusvideo
DA Vejledende video
ET Õppevideo
LV Arpmācību video
LT Mokomasis vaizdo įrašas
RU Обучающее видео
UK Навчальне відео
TR Öğretici video
EL Εκπαιδευτικό βίντεο
RO Video tutorial
IS Kennslumyndband
MT Tutorial fuq vidjow

AR
FA
YUE 教程視頻
CMN 教程视频
JA チュートリアルビデオ
KO 튜토리얼 동영상
BG Учебно видео
SR Video sa uputstvima
MS Video tutorial
HI क्यूटोरियल वीडियो
TH ژیតီໂອນະນຳ
SQ Video udhëzuese
BS Video sa uputstvima
ME Video sa uputstvima
MK Видеоупатство
HY Ուղեցուցիչական տեսանյութ
VI Video hướng dẫn

فيديو تعليمي
ويدئوى آموزشى

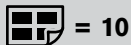

EN Maximum weights
DE Maximalgewichte
ES Pesos máximos
FR Poids maximum
IT Peso massimo
NL Maximumgewicht
PL Dopuszczalna waga
CS Maximální hmotnosti
SK Maximálne hmotnosti
SL Največje teže
HR Maksimalne težine
HU Maximális súlyok
SE Max.vikter
NO Maksimumsvektar
FI Enimmäispainot
DA Maksimumvægt
ET Maksimaalne kaal
LV Maksimālais svars
LT Didžiausi svoriai
RU Максимальная масса
UK Максимальна вага
TR Maksimum ağırlıklar

EL Μέγιστο βάρος
RO Greutăți maxime
IS Hámarksþyngd
MT Piżijiet massimi
AR الأوزان القصوى
FA حداکثر وزن
YUE 最大重量
CMN 最大重量
JA 最大重量
KO 최대 하중
BG Максимални тегла
SR Maksimalne težine
MS Berat maksimum
HI अधिकतम वजन
TH น้ำหนักสูงสุด
SQ Peshat maksimale
BS Maksimalne težine
ME Maksimalne težine
MK Максимални тежини
HY Առավելագույն քաշեր
VI Các mức cân nặng tối đa

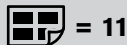

EN Product registration
DE Produktregistrierung
ES Registro del producto
FR Enregistrement du produit
IT Registrazione del prodotto
NL Productregistratie
PL Rejestracja produktu
CS Registrace výrobku
SK Registrácia výrobku
SL Registracija izdelka
HR Registracija proizvoda
HU Termékregisztráció
SE Produktregistrering
NO Produktregistrering
FI Tuotteen rekisteröinti
DA Produktregistrering
ET Toote registreerimine
LV Produkta registrācija
LT Gaminio registracija
RU Регистрация продукта
UK Реєстрація продукту
TR Ürün kaydı

EL Καταχώριση προϊόντος
RO Înregistrarea produsului
IS Skráning tækis
MT Registrazzjoni tal-prodott
AR تسجيل المنتج
FA ثبت محصول
YUE 產品註冊
CMN 产品注册
JA 製品の登録
KO 제품 등록
BG Регистрация на продукта
SR Registracija proizvoda
MS Pendaftaran produk
HI उत्पाद पंजीकरण
TH การลงทะเบียนผลิตภัณฑ์
SQ Regjistrimi i produktit
BS Registracija proizvoda
ME Registracija proizvoda
MK Регистрација на производ
HY Արձարկի գրանցում
VI Đăng ký sản phẩm



 = 12

EN	Set up	EL	Στήσιμο
DE	Aufbau	RO	Setare
ES	Instalación	IS	Uppsetning
FR	Montage	MT	Konfigurazzjoni
IT	Configurazione	AR	تنصيب
NL	Opbouw	FA	برپا کردن
PL	Montaż	YUE	設置
CS	Nastavení	CMN	设置
SK	Nastavenie	JA	セットアップ
SL	Nastavitev	KO	설정
HR	Postavljanje	BG	Настройка
HU	Felszerelés	SR	Postavljanje
SE	Inställning	MS	Persediaan
NO	Oppsett	HI	सेट अप
FI	Asennus	TH	การติดตั้ง
DA	Opsætning	SQ	Konfigurimi
ET	Seadistamine	BS	Postavljanje
LV	Uzstādīšana	ME	Postavljanje
LT	Nuostatos	MK	Поставување
RU	Установка	HY	Շարժափոխում
UK	Встановлення	VI	Cài đặt
TR	Kurulum		



 = 14

EN	Brake	EL	Φρένα
DE	Bremse	RO	Frână
ES	Freno	IS	Bremsa
FR	Frein	MT	Brejġ
IT	Freno	AR	المكابح
NL	Rem	FA	ترمز
PL	Hamulec	YUE	剎車
CS	Brzda	CMN	刹车
SK	Brzda	JA	ブレーキ
SL	Zavora	KO	브레이크
HR	Kočnica	BG	Спирачка
HU	Fék	SR	Kočnica
SE	Broms	MS	Brek
NO	Brems	HI	ब्रेक
FI	Jarru	TH	เบรค
DA	Bremse	SQ	Frenat
ET	Pidur	BS	Kočnica
LV	Bremze	ME	Kočnica
LT	Stabdys	MK	Сопирачка
RU	Тормоза	HY	Արգելակ
UK	Гальма	VI	Phanh thắng
TR	Fren		



EN	Folding
DE	Faltung
ES	Plegado
FR	Pliant
IT	Ripiegamento
NL	Vouwen
PL	Składanie
CS	Skládání
SK	Zloženie
SL	Zlaganje
HR	Preklapanje
HU	Összecsukás
SE	Ihopfällning
NO	Sammenlegging
FI	Kokoon taittaminen
DA	Sammenklapning
ET	Kokkuvoltimine
LV	Salocīšana
LT	Lankstymas
RU	Складывание
UK	Складання
TR	Katlama

EL	Αναδίπλωση
RO	Pliere
IS	Brjótta saman
MT	Tiwi
AR	
FA	
YUE	折疊
CMN	折疊
JA	折りたたみ
KO	접기
BG	Сгъване
SR	Preklapanje
MS	Lipat
HI	फोड़ना
TH	การพับ
SQ	Palosja
BS	Preklapanje
ME	Preklapanje
MK	Склопување
HY	Շալելը
VI	Gập lại

قابلية للطي
تا کردن

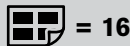

EN	Harness
DE	Gurtsystem
ES	Arnés
FR	Harnais
IT	Imbracatura
NL	Harnas
PL	Szelki
CS	Popruh
SK	Popruh
SL	Varnostni pas
HR	Sustav vezivanja
HU	Biztonsági öv
SE	Sele
NO	Beltsystem
FI	Vyöjärjestelmä
DA	Selesystem
ET	Turvarihmad
LV	Drošības josta
LT	Diržai
RU	Ремни безопасности
UK	Ремінь
TR	Emniyet kemeri

EL	Συγκράτηση
RO	Centură
IS	Beisli
MT	Ġinga tas-sigurtà
AR	
FA	
YUE	安全帶
CMN	安全帶
JA	安全ベルト
KO	하네스
BG	Сбруя
SR	Sistem vezivanja
MS	Abah-abah
HI	कवच
TH	ระบบสายรัด
SQ	Pajimet
BS	Sistem vezivanja
ME	Sistem vezivanja
MK	Сигурносен каиш
HY	Ամրագրուի
VI	Dây an toàn

طقم الشد
سديستم مهار



 = 18

EN	Bumper bar	EL	Μπάρα διάταξης προστασίας
DE	Schutzbügel	RO	Bară de protecție
ES	Barra de seguridad	IS	Pverbiti
FR	Barre de protection	MT	Strixxa tal-bumper
IT	Barra paraurti	AR	عارضة ممتص الصدمات
NL	Veiligheidsbeugel	FA	میله ضربهگیر
PL	Pałak zabezpieczający	YUE	保險杠
CS	Dětské madlo	CMN	保險杠
SK	Detská rúčka	JA	バンパーバー
SL	Varnostni lok	KO	범퍼 바
HR	Štitnik	BG	Броня
HU	Karfa	SR	Štitnik
SE	Stötfångare	MS	Bar bumper
NO	Fender	HI	बम्पर बार
FI	Suojakaari	TH	แถบกันชน
DA	Sikkerhedsbøjle	SQ	Shufra e parakolpit
ET	Turvakaar	BS	Štitnik
LV	Aizsargloks	ME	Štitnik
LT	Amortizatoriaus strypas	MK	Одбојник
RU	Поручень	HY	Թափարգէլ
UK	Обмежувальний поручень	VI	Thanh chống va đập
TR	Tampon çubuğu		



 = 20

EN	Backrest	EL	Πλάτη
DE	Rückenlehne	RO	Spătar
ES	Respaldo	IS	Bak
FR	Dossier	MT	Serħ id-dahar
IT	Schienale	AR	ممسند الظهر
NL	Rugleuning	FA	پشتی
PL	Oparcie	YUE	靠背
CS	Opěradlo	CMN	靠背
SK	Operadlo	JA	背もたれ
SL	Naslonjalo	KO	등받이
HR	Naslon	BG	Облегалка
HU	Háttámla	SR	Naslon
SE	Ryggstöd	MS	Penyangdar belakang
NO	Rygglene	HI	वैक्रेस्ट
FI	Selkänöja	TH	พนักพิง
DA	Ryglæn	SQ	Mbështetësja e shpinës
ET	Seljatugi	BS	Naslon
LV	Atzveltne	ME	Naslon
LT	Nugaros atlošas	MK	Наслон за грб
RU	Спинка	HY	Թիկնակ
UK	Спинка	VI	Phần tựa lưng
TR	Arkalık		



 = 21

EN	Legrest	EL	Στήριγμα ποδιών
DE	Beinstütze	RO	Suport picior
ES	Reposapiés	IS	Fótahvíla
FR	Repose-pieds	MT	Serħ is-saqajn
IT	Poggiagambe	AR	مسند الساق
NL	Beensteun	FA	جاپایی
PL	Podnózek	YUE	腿托
CS	Opěrka nohou	CMN	腿托
SK	Opierka nôh	JA	足のせ
SL	Naslon za noge	KO	다리받이
HR	Naslon za noge	BG	Подложка за крака
HU	Lábtartó	SR	Naslon za noge
SE	Benstöd	MS	Tempat letak kaki
NO	Benstøtte	HI	लेगरेस्ट
FI	Jalkatuki	TH	ที่วางขา
DA	Benstøtte	SQ	Mbështetësja e këmbëve
ET	Jalatuği	BS	Naslon za noge
LV	Kāju balsts	ME	Naslon za noge
LT	Kojų atrama	MK	Наслон за нозе
RU	Подставка для ног	HY	Ուղտրի հենման կտն
UK	Опора для ніг	VI	Phần tựa chân
TR	Bacak desteği		



 = 22

EN	Removing the fabric	EL	Αφαίρεση του υφάσματος
DE	Entfernen des Bezuges	RO	Îndepărtarea țesăturii
ES	Quitar la tela	IS	Fjarlægja efni
FR	Retrait du tissu	MT	Tneħhija tad-drapp
IT	Rimozione del tessuto	AR	فك القماش
NL	De stof verwijderen	FA	برداشتن پارچه
PL	Zdejmowanie pokrycia	YUE	拆除罩布
CS	Odstranění látky	CMN	拆除罩布
SK	Odstránenie látky	JA	カバーの取り外し
SL	Odstranjevanje blaga	KO	페브릭 제거
HR	Uklanjanje tkanine	BG	Демонтиране на плата
HU	Huzat eltávolítása	SR	Uklanjanje tkanine
SE	Ta bort tyget	MS	Menanggalkan fabrik
NO	Fjerne stoffet	HI	कपडा हटाना
FI	Kankaan poisto	TH	การถอดผ้า
DA	Fjernelse af stoffet	SQ	Heqja e copës
ET	Kanga eemaldamine	BS	Uklanjanje tkanine
LV	Pārklājuma atvienošana	ME	Uklanjanje tkanine
LT	Audinio nuėmimas	MK	Отстранување на навлаката
RU	Снятие ткани	HY	Գործվածքը հանելը
UK	Зняття матерії	VI	Tháo phần vải bọc
TR	Kılıfı çikarma		

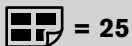

EN	Rain cover	EL	Καλύπτρα βροχής
DE	Regenverdeck	RO	Prelată de ploaie
ES	Funda para la lluvia	IS	Regn yfirbreiðsla
FR	Housse de pluie	MT	Għata mix-xita
IT	Parapioggia	AR	غطاء المطر
NL	Regenhoes	FA	روکش باران
PL	Oslona od deszczu	YUE	防雨罩
CS	Pláštěnka	CMN	防雨罩
SK	Kryt proti dažďu	JA	雨ふけ
SL	Dežna prevleka	KO	레인커버
HR	Pokrivač za kišu	BG	Дъждобран
HU	Esővédő	SR	Pokrivač za kišu
SE	Regnskydd	MS	Pelindung hujan
NO	Kalesje	HI	रेन कवर
FI	Sadesuoja	TH	ผ้าคลุมกันฝน
DA	Regnslag	SQ	Mbulesë për shiun
ET	Vihmakate	BS	Pokrivač za kišu
LV	Pretlietus pārvalks	ME	Pokrivač za kišu
LT	Uždangalas nuo lietaus	MK	Прекривка за дожд
RU	Дождевик	HY	Անձրևապաշտպան ծածկ
UK	Дошовик	VI	Tấm che mưa
TR	Yağmurluk		

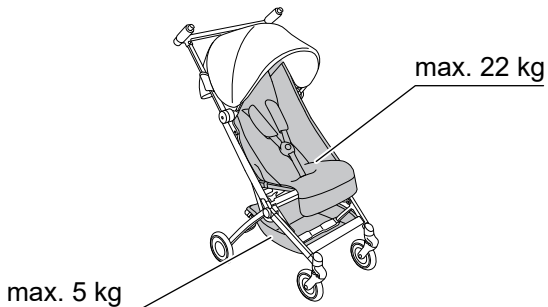

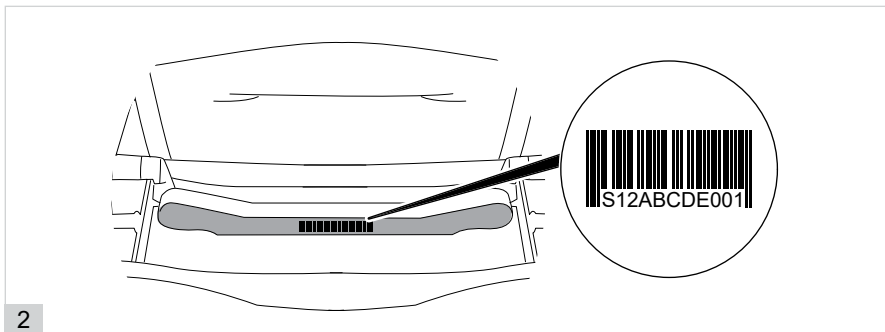
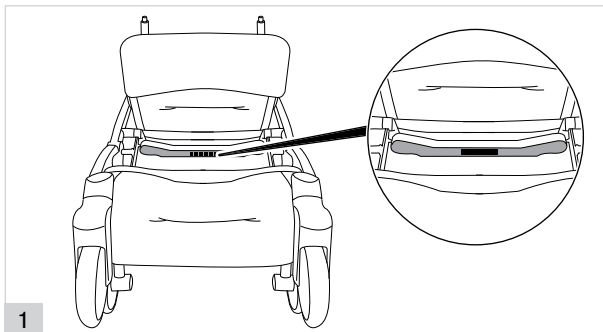



1

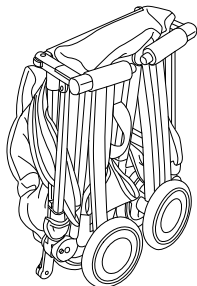

optional



optional

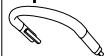

optional



12

2

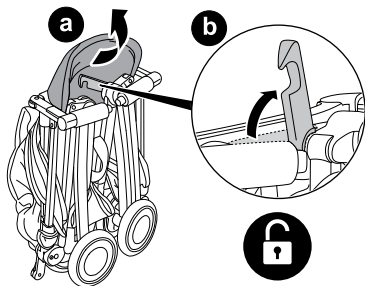

3

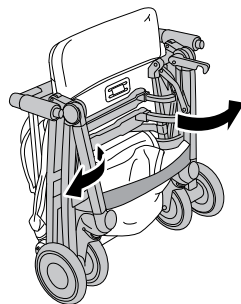

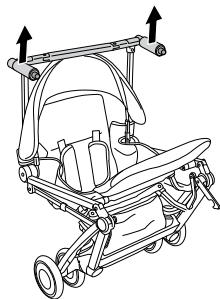

4

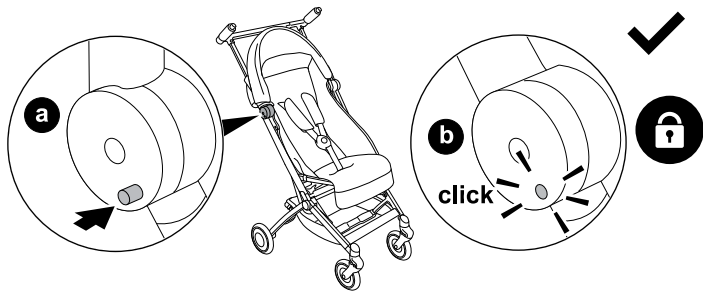

5

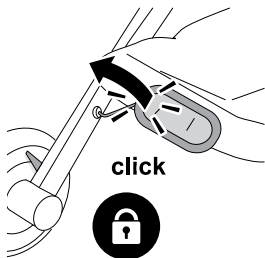

1

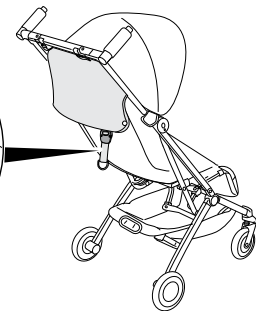
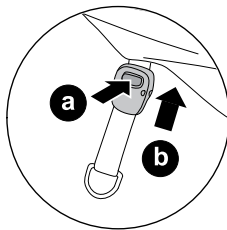
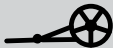
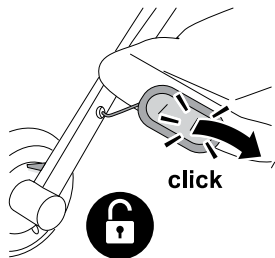

1

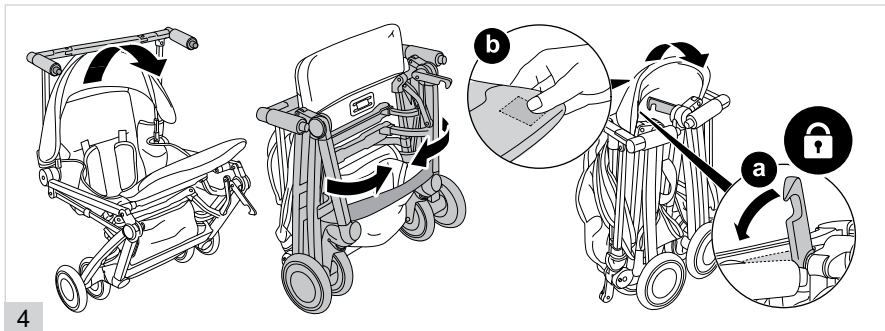
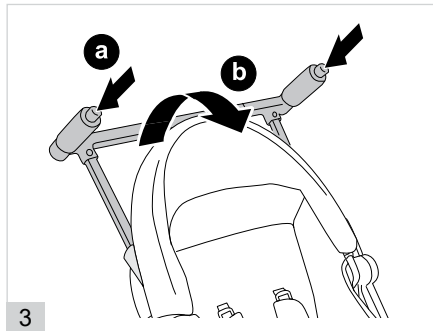

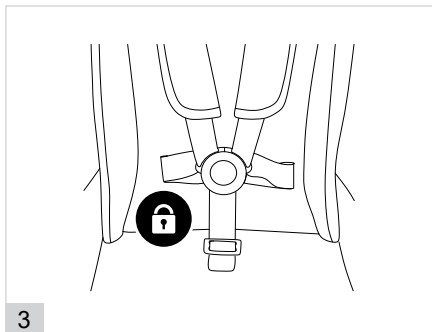
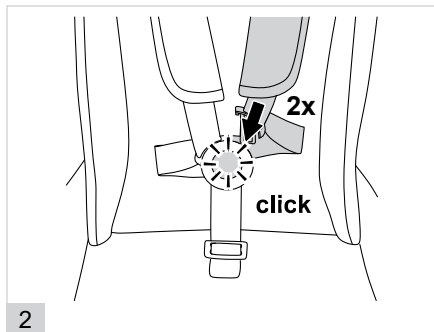
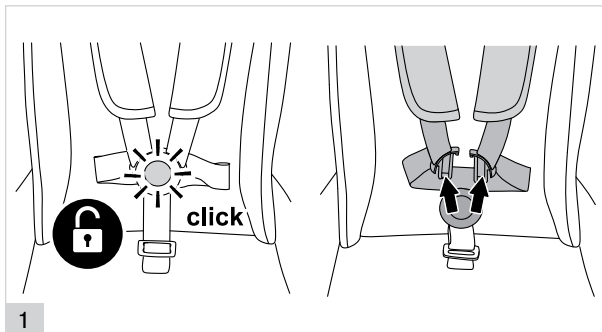

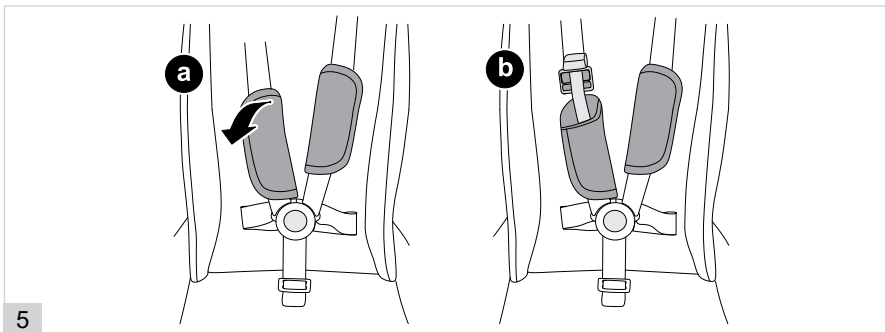
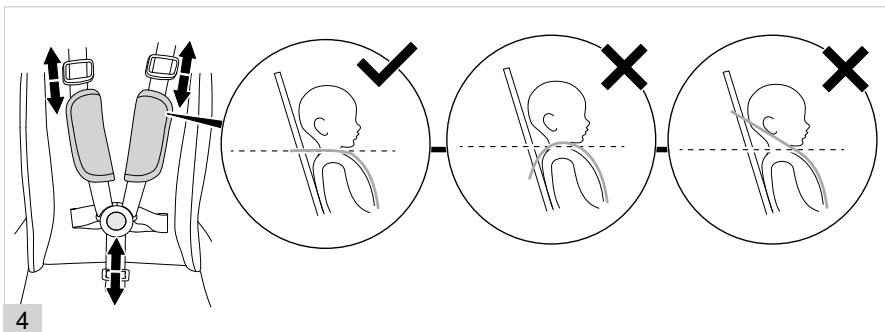

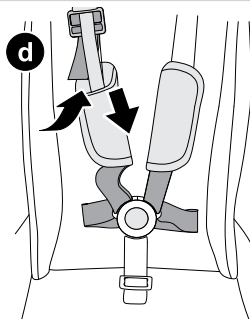
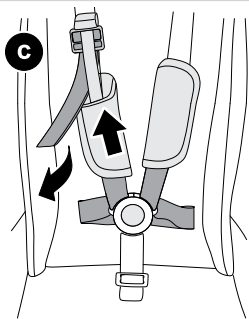

6



optional

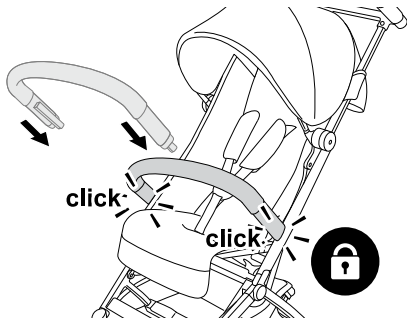

1

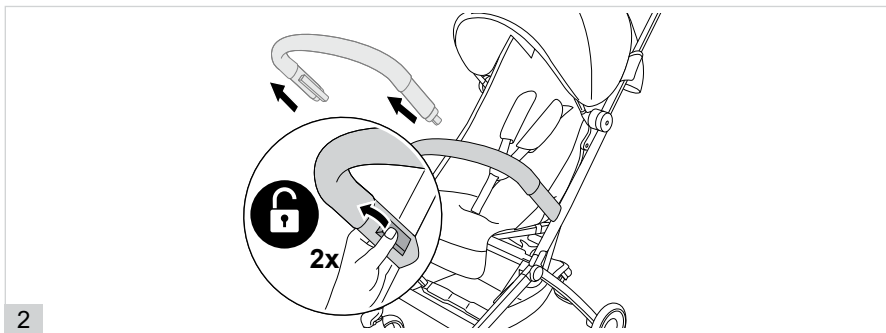

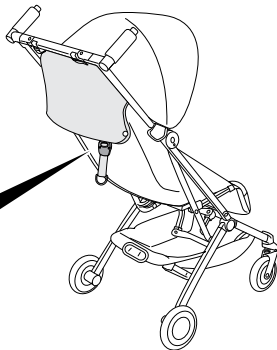
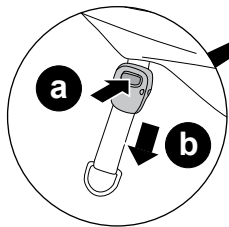
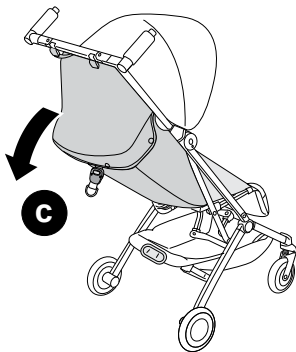

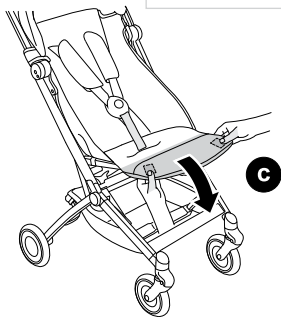
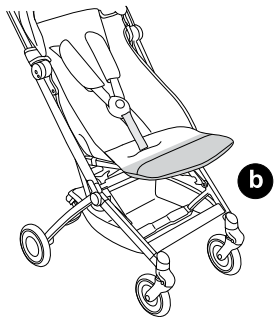

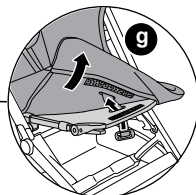
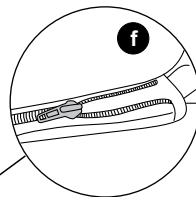
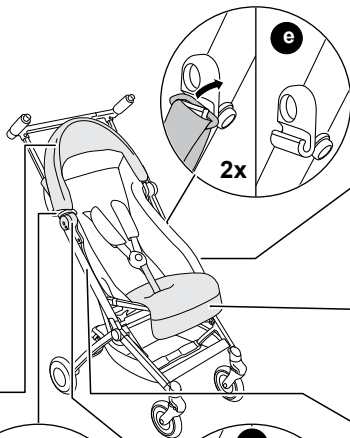
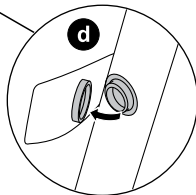
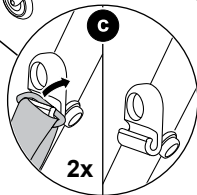
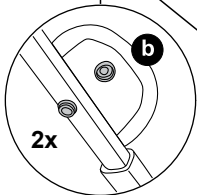
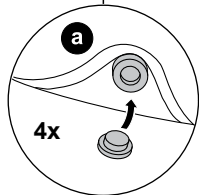

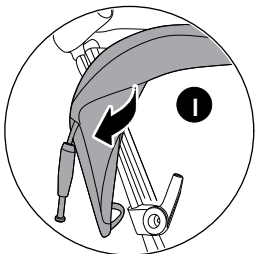
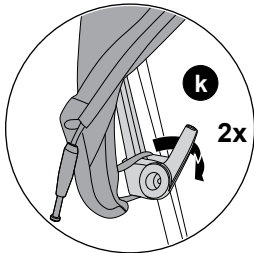
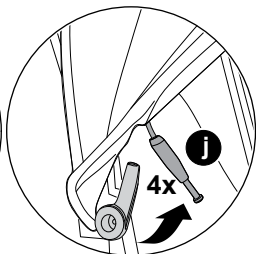
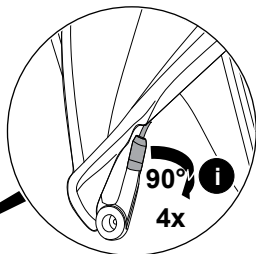
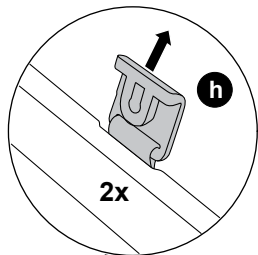

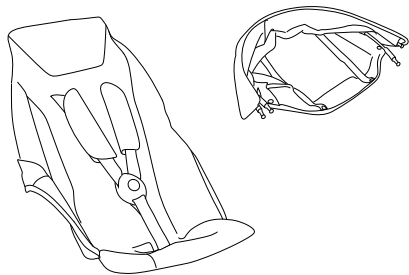

optional

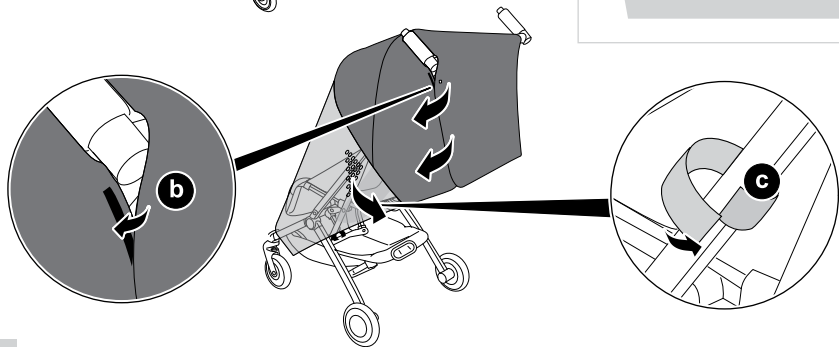
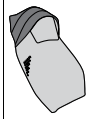

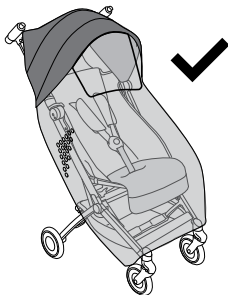

2



CYBEX GmbH

Riedingerstr. 18 | 95448 Bayreuth | Germany
+49 (0) 921-78 511-0 | info@cybex-online.com

www.cybex-online.com

