

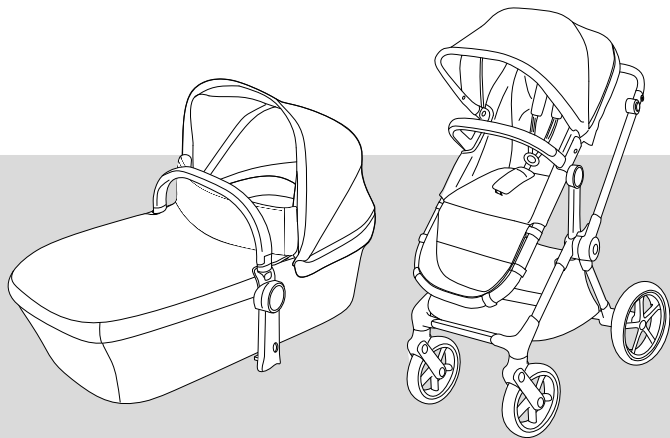

EOS LUX





EN WARNING
DE WARNUNG
ES ADVERTENCIA
FR AVERTISSEMENT
PT AVISOS
IT ATTENZIONE
NL WAARSCHUWING
PL OSTRZEŻENIE
CS UPOZORNĚNÍ
SK UPOZORNENIE
SL OPOZORILO
HR UPOZORENJE
HU FIGYELMEZTETÉS
SE VARNING
NO ADVARSEL
FI VAROITUS
DA ADVARSEL
ET HOIATUS
LV BRĪDINĀJUMS
LT PERSPĖJIMAS
RU ВНИМАНИЕ
UK УВАГА
TR UYARI
EL ΠΡΟΕΙΔΟΠΟΙΗΣΗ
RO AVERTISMENTE
IS VIÐVÖRUN
MT TWISSIJA

AR
FA
YUE 警告
CMN 警告
JA 警告
KO 경고
BG ПРЕДУПРЕЖДЕНИЕ
SR UPOZORENJE
MS AMARAN
HI चेतावनी
TH คำเตือน
SQ PARALAJMËRIM
BS UPOZORENJE
ME UPOZORENJE
MK ПРЕДУПРЕДУВАЊЕ
HY ՉԳՈՒԲԱՅՈՒԴ
VI CẢNH BÁO

تحذير
اخطار



EN Tutorial video
DE Videoanleitung
ES Tutorial en vídeo
FR Vidéo de démonstration
PT Video tutorial
IT Video tutorial
NL Instructievideo
PL Film instruktażowy
CS Výukové video
SK Výukové video
SL Video z navodili
HR Video s uputama
HU Bemutatóvideó
SE Videosjälvstudiekurs
NO Opplæringsvideo
FI Opetusvideo
DA Vejledende video
ET Õppevideo
LV Arpmācību video
LT Mokomasis vaizdo įrašas
RU Обучающее видео
UK Навчальне відео
TR Öğretici video
EL Εκπαιδευτικό βίντεο
RO Video tutorial
IS Kennslumyndband
MT Tutorial fuq vidjow

AR
FA
YUE 教程視頻
CMN 教程視頻
JA チュートリアルビデオ
KO 튜토리얼 동영상
BG Учебно видео
SR Video sa uputstvima
MS Video tutorial
HI क्यूटोरियल वीडियो
TH 3D ฝึกอบรม
SQ Video udhëzuese
BS Video sa uputstvima
ME Video sa uputstvima
MK Видеоупатство
HY Πληροφοριακά υποστηρικτικά
VI Video hướng dẫn

فيديو تعليمي
ويديو آموزشی

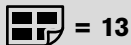

= 13

EN	Maximum weights	TR	Maksimum ağırlıklar
DE	Maximalgewichte	EL	Μέγιστο βάρος
ES	Pesos máximos	RO	Greutăți maxime
FR	Poids maximum	IS	Hámarksþyngd
PT	Pesos máximos	MT	Piżijiet massimi
IT	Peso massimo	AR	الأوزان القصوى
NL	Maximengewicht	FA	حداکثر وزن
PL	Dopuszczalna waga	YUE	最大重量
CS	Maximální hmotnosti	CMN	最大重量
SK	Maximálne hmotnosti	JA	最大重量
SL	Največje teže	KO	최대 하중
HR	Maksimalne težine	BG	Максимални тегла
HU	Maximális súlyok	SR	Maksimalne težine
SE	Max.vikter	MS	Berat maksimum
NO	Maksimumsvektor	HI	अधिकतम बजन
FI	Enimmäispainot	TH	น้ำหนักสูงสุด
DA	Maksimumvægt	SQ	Peshat maksimale
ET	Maksimaalne kaal	BS	Maksimalne težine
LV	Maksimālais svars	ME	Maksimalne težine
LT	Didžiausi svoriai	MK	Максимални тежини
RU	Максимальная масса	HY	Առավելագույն քաշեր
UK	Максимальна вага	VI	Các mức cân nặng tối đa

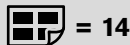

= 14

EN	Product registration	TR	Ürün kaydı
DE	Produktregistrierung	EL	Καταχώριση προϊόντος
ES	Registro del producto	RO	Înregistrarea produsului
FR	Enregistrement du produit	IS	Skráning tækis
PT	Registo do produto	MT	Reġistrazzjoni tal-prodott
IT	Registrazione del prodotto	AR	تسجيل المنتج
NL	Productregistratie	FA	ثبت محصول
PL	Rejestracja produktu	YUE	產品註冊
CS	Registrace výrobku	CMN	产品注册
SK	Registrácia výrobku	JA	製品の登録
SL	Registracija izdelka	KO	제품 등록
HR	Registracija proizvoda	BG	Регистрация на продукта
HU	Termékregisztráció	SR	Registracija proizvoda
SE	Produktregistrering	MS	Pendaftaran produk
NO	Produktregistrering	HI	उत्पाद पंजीकरण
FI	Tuotteen rekisteröinti	TH	การลงทะเบียนผลิตภัณฑ์
DA	Produktregistrering	SQ	Regjistrimi i produktit
ET	Toote registreerimine	BS	Registracija proizvoda
LV	Produkta registrācija	ME	Registracija proizvoda
LT	Gaminio registracija	MK	Регистрација на производ
RU	Регистрация продукта	HY	Արարվող արարվումը
UK	Реєстрація продукту	VI	Đăng ký sản phẩm



= 18

EN	Set up	EL	Στήσιμο
DE	Aufbau	RO	Setare
ES	Instalación	IS	Uppsetning
FR	Montage	MT	Konfigurazzjoni
PT	Preparação	AR	تنصيب
IT	Configurazione	FA	بريا کردن
NL	Opbouw	YUE	設置
PL	Montaż	CMN	设置
CS	Nastavení	JA	セットアップ
SK	Nastavenie	KO	설정
SL	Nastavitev	BG	Настройка
HR	Postavljanje	SR	Postavljanje
HU	Felszerelés	MS	Persediaan
SE	Inställning	HI	सेट अप
NO	Oppsett	TH	การติดตั้ง
FI	Asennus	SQ	Konfigurimi
DA	Opsætning	BS	Postavljanje
ET	Seadistamine	ME	Postavljanje
LV	Uzstādīšana	MK	Поставување
LT	Nuostatos	HY	Շարժափոխում
RU	Установка	VI	Cài đặt
UK	Встановлення	TR	Kurulum



= 34

EN	Brake	EL	Φρένα
DE	Bremse	RO	Frână
ES	Freno	IS	Bremsa
FR	Frein	MT	Brejġ
PT	Bloqueio	AR	المكابح
IT	Freno	FA	ترمز
NL	Rem	YUE	剎車
PL	Hamulec	CMN	刹车
CS	Brzda	JA	ブレーキ
SK	Brzda	KO	브레이크
SL	Zavora	BG	Спирачка
HR	Kočnica	SR	Kočnica
HU	Fék	MS	Brek
SE	Broms	HI	ब्रेक
NO	Brems	TH	เบรค
FI	Jarru	SQ	Frenat
DA	Bremse	BS	Kočnica
ET	Pidur	ME	Kočnica
LV	Bremze	MK	Сопирачка
LT	Stabdys	HY	Սրբեխալ
RU	Тормоза	VI	Phanh thắng
UK	Гальма		
TR	Fren		



 = 34

EN Folding
DE Faltung
ES Plegado
FR Pliant
PT Fecho
IT Ripiegamento
NL Vouwen
PL Składanie
CS Skládání
SK Zloženie
SL Zlaganje
HR Preklapanje
HU Összecsukás
SE Ihopfällning
NO Sammenlegging
FI Kokoon taittaminen
DA Sammenklapning
ET Kokkuvoltimine
LV Salocišana
LT Lankstymas
RU Складывание
UK Складання
TR Katlama

EL Αναδίπλωση
RO Pliere
IS Brjóta saman
MT Tiwi
AR قابلة للطى
FA تا کردن
YUE 折疊
CMN 折疊
JA 折りたたみ
KO 접기
BG Сгъване
SR Preklapanje
MS Lipat
HI फोल्डिंग
TH การพับ
SQ Palosja
BS Preklapanje
ME Preklapanje
MK Склопување
HY ժալելը
VI Gập lại



 = 38

EN Folding
DE Faltung
ES Plegado
FR Pliant
PT Fecho
IT Ripiegamento
NL Vouwen
PL Składanie
CS Skládání
SK Zloženie
SL Zlaganje
HR Preklapanje
HU Összecsukás
SE Ihopfällning
NO Sammenlegging
FI Kokoon taittaminen
DA Sammenklapning
ET Kokkuvoltimine
LV Salocišana
LT Lankstymas
RU Складывание
UK Складання
TR Katlama

EL Αναδίπλωση
RO Pliere
IS Brjóta saman
MT Tiwi
AR قابلة للطى
FA تا کردن
YUE 折疊
CMN 折疊
JA 折りたたみ
KO 접기
BG Сгъване
SR Preklapanje
MS Lipat
HI फोल्डिंग
TH การพับ
SQ Palosja
BS Preklapanje
ME Preklapanje
MK Склопување
HY ժալելը
VI Gập lại



 = 44

EN	Harness	EL	Συγκράτηση
DE	Gurtsystem	RO	Centură
ES	Arnés	IS	Beisli
FR	Harnais	MT	Ċinga tas-sigurtà
PT	Arnês	AR	طقم الشد
IT	Imbracatura	FA	سیستم مهار
NL	Harnas	YUE	安全帶
PL	Szelki	CMN	安全帶
CS	Popruh	JA	安全ベルト
SK	Popruh	KO	하네스
SL	Varnostni pas	BG	Сбруя
HR	Sustav vezivanja	SR	Sistem vezivanja
HU	Biztonsági öv	MS	Abah-abah
SE	Sele	HI	कवच
NO	Beltsystem	TH	ระบบสายรัด
FI	Vyöjärjestelmä	SQ	Pajimet
DA	Selesystem	BS	Sistem vezivanja
ET	Turvarihmad	ME	Sistem vezivanja
LV	Drošības josta	MK	Сигурносен каиш
LT	Diržai	HY	Ամրապոսի
RU	Ремни безопасности	VI	Dây an toàn
UK	Ремінь		
TR	Emniyet kemeri		



 = 47

EN	Bumper bar	TR	Tampon çubuğu
DE	Schutzbügel	EL	Μπάρα διάταξης ροστασίας
ES	Barra de seguridad	RO	Bară de protecție
FR	Barre de protection	IS	Þverbiti
PT	Barra de segurança	MT	Strixxa tal-bumper
IT	Barra paraurti	AR	عارضة ممتص الصدمات
NL	Veiligheidsbeugel	FA	ميله ضربه گیر
PL	Pałak zabezpieczający	YUE	保險杠
CS	Dětské madlo	CMN	保險杠
SK	Detská rúčka	JA	バンパーバー
SL	Varnostni lok	KO	범퍼 바
HR	Štitnik	BG	Броня
HU	Karfa	SR	Štitnik
SE	Stötfångare	MS	Bar bamper
NO	Fender	HI	बम्पर बर
FI	Suojakaari	TH	แบริงกันชน
DA	Sikkerhedsbøjle	SQ	Shufra e parakolpit
ET	Turvakaar	BS	Štitnik
LV	Aizsargloks	ME	Štitnik
LT	Amortizatoriaus strygas	MK	Одбојник
RU	Поручень	HY	Թափարգել
UK	Обмежувальний поручень	VI	Thanh chống va đập



 = 48

EN	Seat direction	EL	Κατεύθυνση καθίσματος
DE	Sitzrichtung	RO	Direcție scaun
ES	Dirección de la silla	IS	Sætisstefna
FR	Sens du siège	MT	Direzzjoni tas-sit
PT	Orientação do assento	AR	اتجاه المقعد
IT	Direzione di seduta	FA	جهت صندلی
NL	Zitrichting	YUE	座椅方向
PL	Kierunek siedzenia	CMN	座椅方向
CS	Směr sedadla	JA	シートの方向
SK	Smer sedadla	KO	좌석 방향
SL	Smer sedeža	BG	Посока на седалката
HR	Smjer sjedala	SR	Smer sedišta
HU	Ülésirány	MS	Arah kerusi
SE	Sitsriktning	HI	सीट दिशा
NO	Seteretning	TH	ทิศทางที่นั่ง
FI	Istumasuunta	SQ	Drejtimi i ndenjësës
DA	Sæderetning	BS	Smjer sjedišta
ET	Istme suund	ME	Smjer sjedišta
LV	Sēdekļa virziens	MK	Правец на седиште
LT	Kėdutės kryptis	HY	Ստամանդի ուղղություն
RU	Направление сиденья	VI	Hướng ghế ngồi
UK	Напрямок сидіння		
TR	Koltuk yönü		



 = 49

EN	Backrest	EL	Πλάτη
DE	Rückenlehne	RO	Spătar
ES	Respaldo	IS	Bak
FR	Dossier	MT	Serħ id-dahar
PT	Encosto de costas	AR	مسند الظهر
IT	Schienale	FA	پشتی
NL	Rugleuning	YUE	靠背
PL	Oparcie	CMN	靠背
CS	Opěradlo	JA	背もたれ
SK	Operadlo	KO	등받이
SL	Naslonjalo	BG	Облегалка
HR	Naslon	SR	Naslon
HU	Háttámla	MS	Penyangdar belakang
SE	Ryggstöd	HI	बैक्रेस्ट
NO	Rygglene	TH	พนักพิง
FI	Selkänoja	SQ	Mbështetësja e shpinës
DA	Ryglæn	BS	Naslon
ET	Seljatugi	ME	Naslon
LV	Atzveltne	MK	Наслон за грб
LT	Nugaros atlošas	HY	Թիկնակ
RU	Спинка	VI	Phấn tựa lưng
UK	Спинка		
TR	Arkalık		

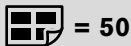

EN	Sun canopy	EL	Κουκούλα για τον ήλιο
DE	Sonnenverdeck	RO	Copertină
ES	Capota para el sol	IS	Sólartjald
FR	Pare-soleil	MT	Kopertura mix-xemx
PT	Capota solar	AR	مظلة الشمس
IT	Parasole	FA	سایبان
NL	Zonnekap	YUE	遮陽蓬
PL	Oslona przeciwsłoneczna	CMN	遮阳蓬
CS	Stříška proti slunci	JA	日よけカバー
SK	Strieška proti slnku	KO	선 캐노피
SL	Senčnik za zaščito pred soncem	BG	Тента
HR	Tenda za sunce	SR	Tenda za sunce
HU	Kupola	MS	Kanopi matahari
SE	Solsufflett	HI	धूप छतरी
NO	Solskjerm	TH	หลังคาบังแดด
FI	Aurinkokatot	SQ	Strea për diellin
DA	Solkaleche	BS	Tenda za sunce
ET	Päikesevari	ME	Tenda za sunce
LV	Saules aizsegs	MK	Стреа за сонце
LT	Stogelis nuo saulės	HY	Սրբապաշտպան ծածկ
RU	Солнцезащитный козырек	VI	Mái che nắng
UK	Тент від сонця		
TR	Güneş başlığı		

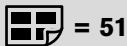

EN	Handle bar	EL	Ράβρος λαβής
DE	Schiebegriff	RO	Mâner
ES	Manillar	IS	Handfang
FR	Poignée de poussée	MT	Handle bar
PT	Guiador	AR	عارضة المقبض
IT	Manubrio	FA	میله دسته
NL	Duwstang	YUE	把手
PL	Uchwyt	CMN	把手
CS	Madlo	JA	ハンドルバー
SK	Rukoväť	KO	핸들 바
SL	Ročaj	BG	Кормило
HR	Ručice	SR	Ručke
HU	Tolókar	MS	Bar pemegang
SE	Handtag	HI	हैंडल बार
NO	Håndtak	TH	ด้ามจับ
FI	Työntökahva	SQ	Shufra e dorezës
DA	Styr	BS	Ručice
ET	Sang	ME	Ručke
LV	Rokturis	MK	Рачка
LT	Rankena	HY	Կարալվարման բռնակ
RU	Рукоятка	VI	Tay cặm
UK	Рукоятка		
TR	Tutma sapı		



= 52

EN Swivel locks	EL Περιστρεφόμενες κλειδαριές
DE Schwenkradsperre	RO Încuietori pivotante
ES Bloqueos de dirección	IS Snúningslásar
FR Verrous pivotants	MT Lokks li jduru
PT Bloqueios de rotação	AR أقفال دوران العجلات
IT Blocchi girevoli	FA قفل های نوسان
NL Zwenkvergrendeling	YUE 旋轉鎖
PL Blokada obrotu	CMN 旋转锁
CS Aretační zámky	JA 回転口ツク
SK Aretačné zámky	KO 회전 잠금장치
SL Blokada vrtenja	BG Завъртащи се ключалки
HR Zaključavanje okretanja	SR Zakretni mehanizmi
HU Beállás-zár	MS Kunci ayun
SE Vridlås	HI कुंडा ताले
NO Svingelåser	TH ตัวล็อกแบบหมุน
FI Kääntölukko	SQ Kucja e rrotave
DA Drejelås	BS Zakretni mehanizmi
ET Pöördlukustus	ME Zakretni mehanizmi
LV Rotācijas bloķētāji	MK Заклучување на тркалата
LT Šarnyriniai fiksatoriai	HY Ἄπικυλῆς ὑποψήζυτες
RU Блокировки вращения	VI Khóa xoay
UK Замок шарніра	
TR Tekerlek kilidi	



= 53

EN Removing the wheels	EL Αφαίρεση των τροχών
DE Entfernen der Räder	RO Îndepărtarea roților
ES Quitar las ruedas	IS Fjarlægja hjól
FR Retrait des roues	MT Tneħhija tar-roti
PT Remover as rodas	AR فك العجلات
IT Rimozione delle ruote	FA باز کردن چرخها
NL De wielen verwijderen	YUE 拆卸車輪
PL Zdejmowanie kółek	CMN 拆卸车轮
CS Odstranění koleček	JA 車輪の取り外し
SK Odstránenie koliesok	KO 휠 제거
SL Odstranjevanje koles	BG Демонтиране на колелата
HR Uklanjanje kotača	SR Uklanjanje točkova
HU Kerekeltávolítás	MS Menanggalkan roda
SE Ta bort hjulen	HI पहियों को हटाना
NO Fjerne hjulene	TH การถอดล้อ
FI Pyörien poisto	SQ Heqja e rrotave
DA Fjernelse af hjulene	BS Uklanjanje točkova
ET Rataste eemaldamine	ME Uklanjanje točkova
LV Riteņu atvienošana	MK Отстранување на тркалата
LT Ratų nuėmimas	HY Արվակները հանելը
RU Снятие колес	VI Tháo bánh xe
UK Зняття коліс	
TR Tekerlekleri çıkarma	



 = 54

EN	Removing the fabric	TR	Kilifi çıkarma
DE	Entfernen des Bezuges	EL	Αφαίρεση του υφάσματος
ES	Quitar la tela	RO	Îndepărtarea țesăturii
FR	Retrait du tissu	IS	Fjarlægja efni
PT	Remover o tecido	MT	Tnehhija tad-drapp
IT	Rimozione del tessuto	AR	فك القماش
NL	De stof verwijderen	FA	برداشتن پارچه
PL	Zdejmowanie pokrycia	YUE	拆除罩布
CS	Odstranění látky	CMN	拆除罩布
SK	Odstránenie látky	JA	カバーの取り外し
SL	Odstranjevanje blaga	KO	페브릭 제거
HR	Uklanjanje tkanine	BG	Демонтиране на плата
HU	Huzat eltávolítása	SR	Uklanjanje tkanine
SE	Ta bort tyget	MS	Menanggalkan fabrik
NO	Fjerne stoffet	HI	कपड़ा हटाना
FI	Kankaan poisto	TH	การถอดผ้า
DA	Fjernelse af stoffet	SQ	Heqja e copës
ET	Kanga eemaldamine	BS	Uklanjanje tkanine
LV	Pārklājuma atvienošana	ME	Uklanjanje tkanine
LT	Audinio nuėmimas	MK	Отстранување на навлаката
RU	Снятие ткани	HY	Գործվածքը հանելը
UK	Зняття матерії	VI	Tháo phần vải bọc



 = 60

EN	Removing the fabric	EL	Αφαίρεση του υφάσματος
DE	Entfernen des Bezuges	RO	Îndepărtarea țesăturii
ES	Quitar la tela	IS	Fjarlægja efni
FR	Retrait du tissu	MT	Tnehhija tad-drapp
PT	Remover o tecido	AR	فك القماش
IT	Rimozione del tessuto	FA	برداشتن پارچه
NL	De stof verwijderen	YUE	拆除罩布
PL	Zdejmowanie pokrycia	CMN	拆除罩布
CS	Odstranění látky	JA	カバーの取り外し
SK	Odstránenie látky	KO	페브릭 제거
SL	Odstranjevanje blaga	BG	Демонтиране на плата
HR	Uklanjanje tkanine	SR	Uklanjanje tkanine
HU	Huzat eltávolítása	MS	Menanggalkan fabrik
SE	Ta bort tyget	HI	कपड़ा हटाना
NO	Fjerne stoffet	TH	การถอดผ้า
FI	Kankaan poisto	SQ	Heqja e copës
DA	Fjernelse af stoffet	BS	Uklanjanje tkanine
ET	Kanga eemaldamine	ME	Uklanjanje tkanine
LV	Pārklājuma atvienošana	MK	Отстранување на навлаката
LT	Audinio nuėmimas	HY	Գործվածքը հանելը
RU	Снятие ткани	VI	Tháo phần vải bọc
UK	Зняття матерії		
TR	Kilifi çıkarma		



 = 70

EN	Infant Car Seat	TR	Bebek Araba Koltuğu
DE	Babyschale	EL	Παιδικό κάθισμα αυτοκινήτου
ES	Silla infantil para coche	RO	Scaunul auto pentru infant
FR	Siège auto pour enfant	IS	Smábarnabilstóll
PT	Cadeira auto infantil	MT	Sit tal-Karozza tat-Tfal
IT	Seggiolino per auto	AR	مقعد سيارة للرضع
NL	Autostoeltje	FA	صندلی خودرو برای نوزاد
PL	Fotelik dla niemowlaka	YUE	嬰兒汽車座椅
CS	Vajičko	CMN	婴儿汽车座椅
SK	Autosedačka pre dojčatá	JA	幼児用カーシート
SL	Avtosedež za dojenčke	KO	유아용 카시트
HR	Autosjedalica za bebe	BG	Бибешка седалка за автомобил
HU	Gyermekek autósülés	SR	Auto sedište za bebe
SE	Bilbarnstol	MS	Kerusi Keselamatan Bayi
NO	Barnebilsete	HI	शिशु कार सीट
FI	Lasten istuin	TH	คาร์ซีทสำหรับเด็กทารก
DA	Autostol	SQ	Sexholino
ET	Imiku turvatool	BS	Auto sjedište za bebe
LV	Zidaiņu sēdekļis	ME	Auto sjedište za bebe
LT	Automobilinė naujagimio kėdutė	MK	Детско седиште за автомобил
RU	Детское автокресло	HY	Վնդոսսեդեքնայի մանկական նստատեղ
UK	Автокрісло для немовлят	VI	Ghế xe dành cho trẻ sơ sinh



 = 72

EN	Rain cover	EL	Καλύπτρα βροχής
DE	Regenverdeck	RO	Prelată de ploaie
ES	Funda para la lluvia	IS	Regn yfirbreiðsla
FR	Housse de pluie	MT	Għata mix-xita
PT	Capa de chuva	AR	غطاء المطر
IT	Parapioggia	FA	روکش باران
NL	Regenhoes	YUE	防雨罩
PL	Oslona od deszczu	CMN	防雨罩
CS	Pláštěnka	JA	雨よけ
SK	Kryt proti dažďu	KO	레인커버
SL	Dežna prevleka	BG	Дъждобран
HR	Pokrivač za kišu	SR	Pokrivač za kišu
HU	Esővédő	MS	Pelindung hujan
SE	Regnskydd	HI	रेन कवर
NO	Kalesje	TH	ผ้าคลุมกันฝน
FI	Sadesuoja	SQ	Mbulesë për shiun
DA	Regnslag	BS	Pokrivač za kišu
ET	Vihmakate	ME	Pokrivač za kišu
LV	Pretlietus pārvalks	MK	Прекиривка за дожд
LT	Uždangalas nuo lietaus	HY	Ածրևապաշտպան ծածկ
RU	Дождевик	VI	Tấm che mưa
UK	Дошовик		
TR	Yağmurluk		

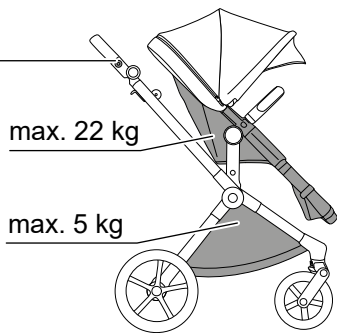
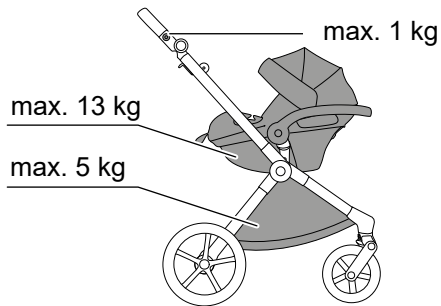
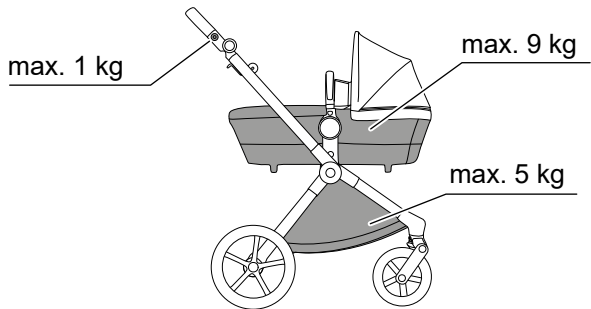

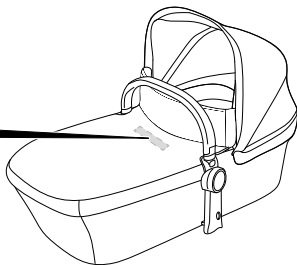
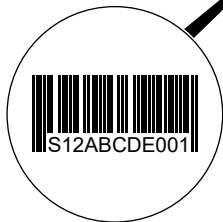
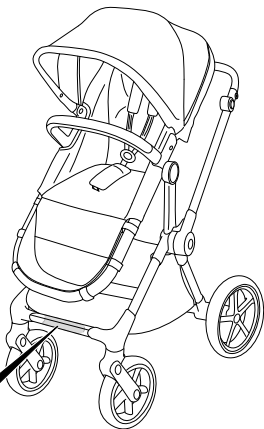

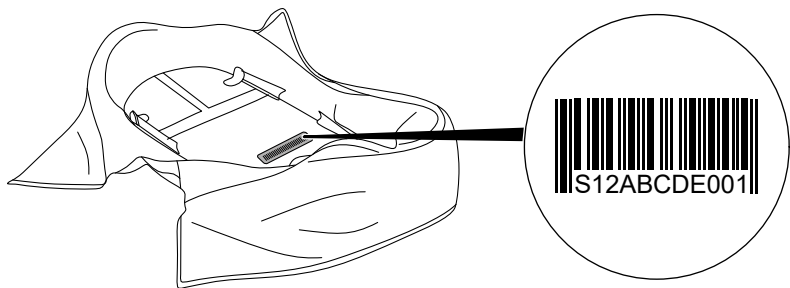

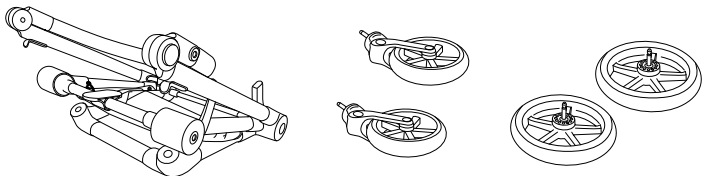
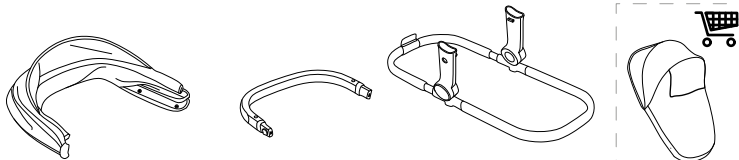
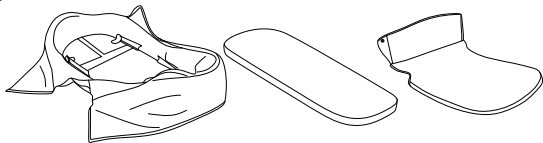
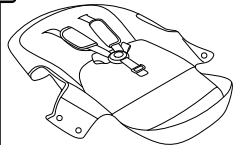
A**B****C****D**

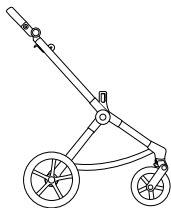

A



29

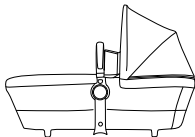

B + C

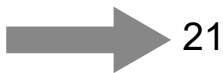

21

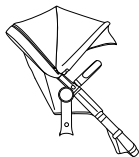

B + D

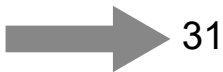

31



A

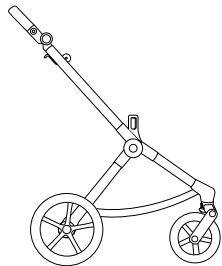

1

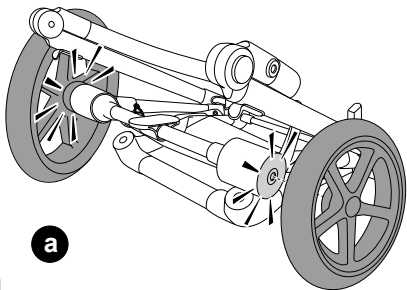

a

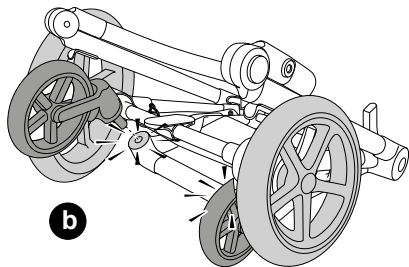

b

2



a

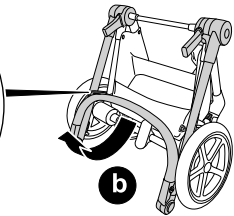
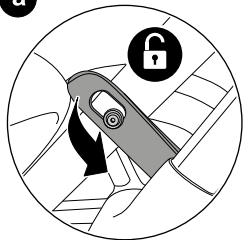

c

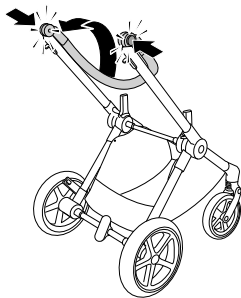

3

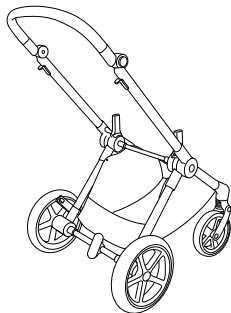

4

B + **C**

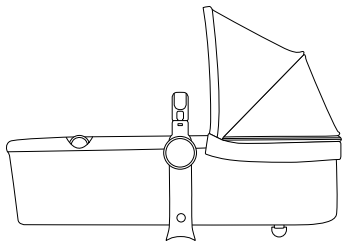

5

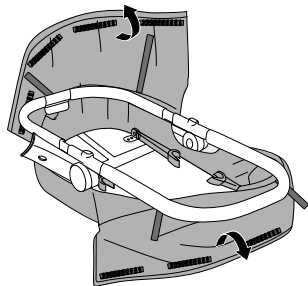
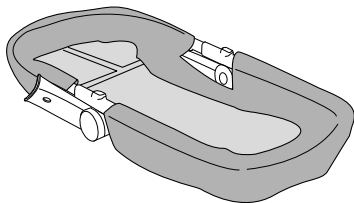

6

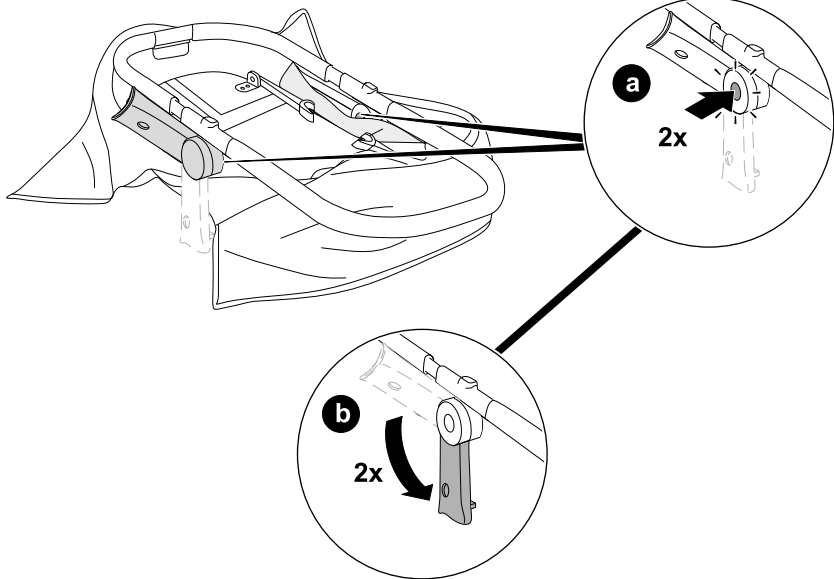

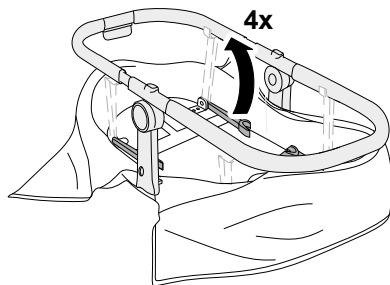

8

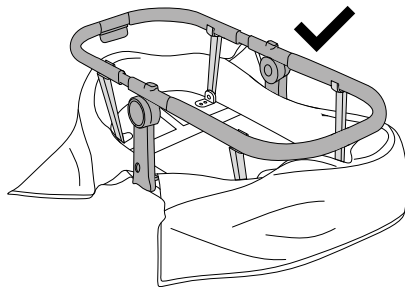

9

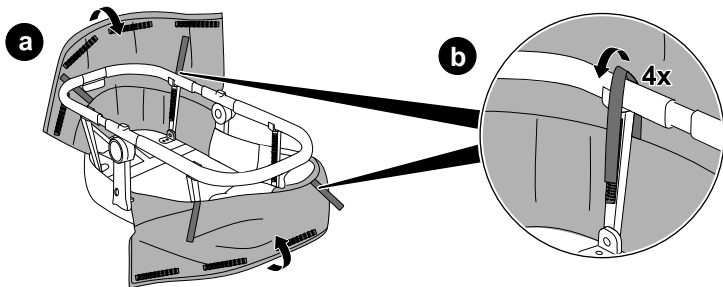

10

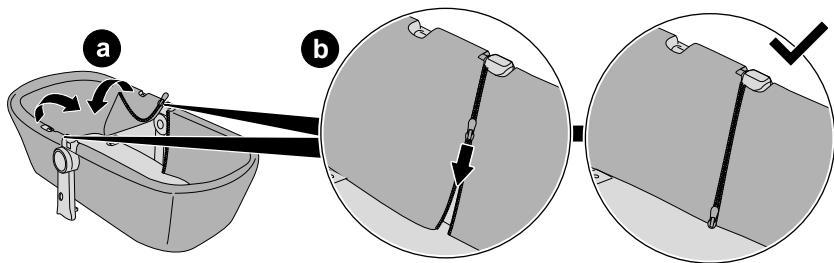

11

23

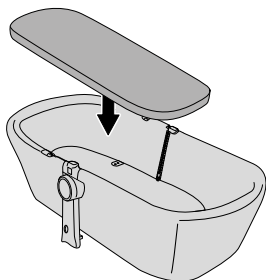

12

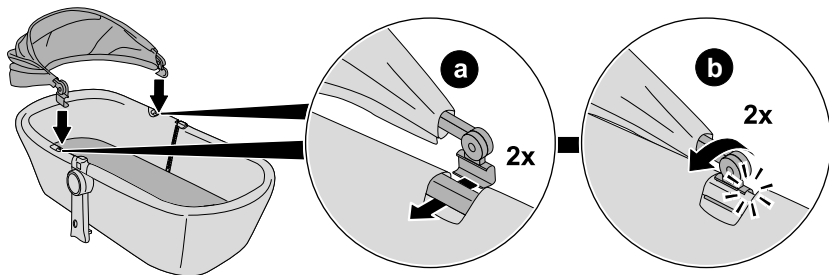

24

13

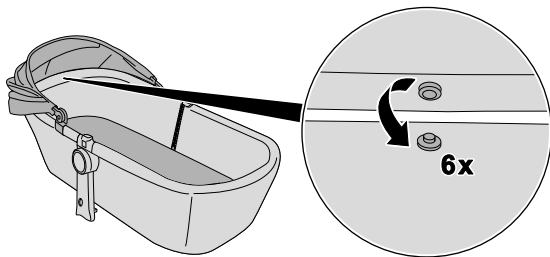

14

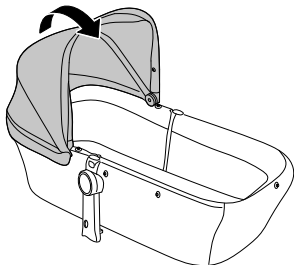

15

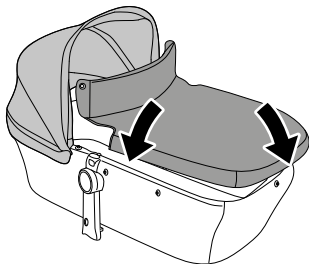

16

25

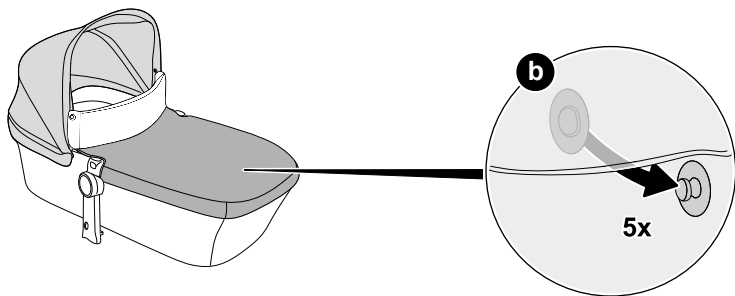
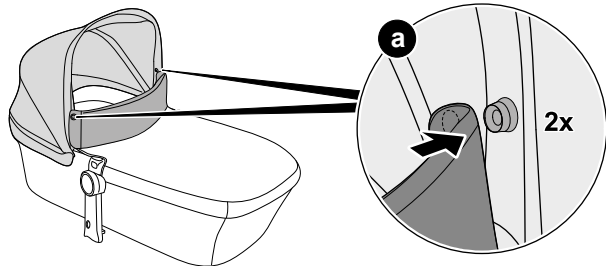

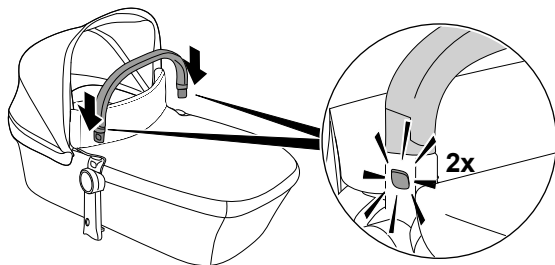

18

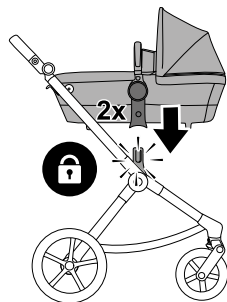
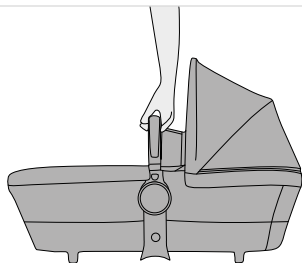

19

27

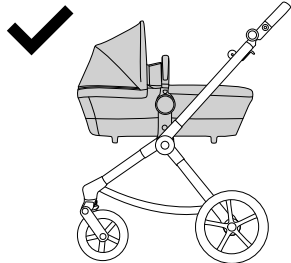
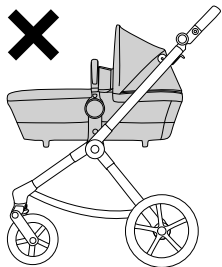

20

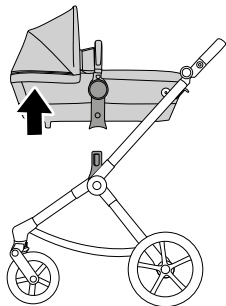
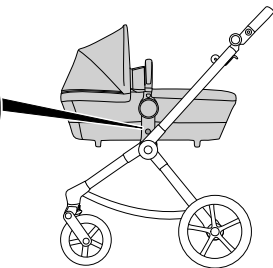
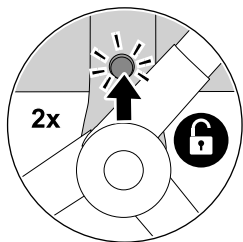

28

21



B + D

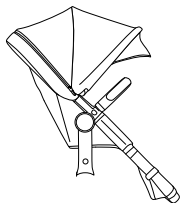

22

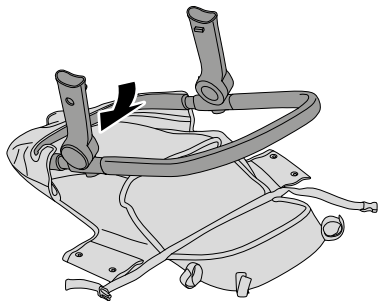

23

29

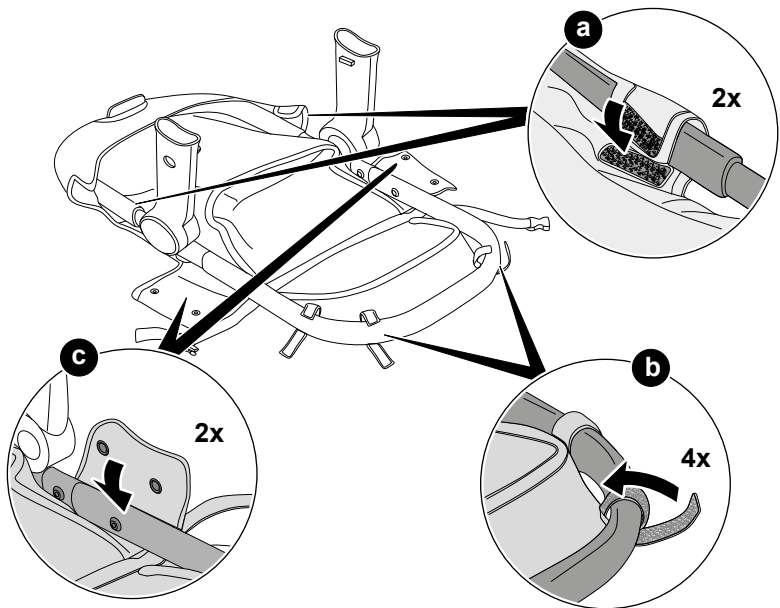

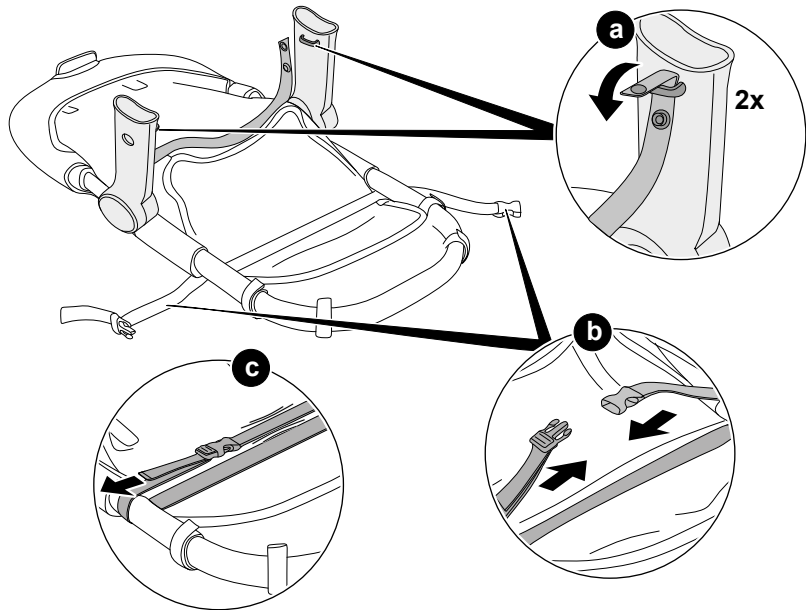

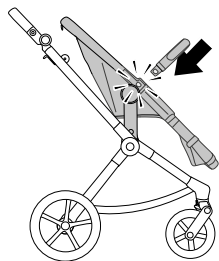
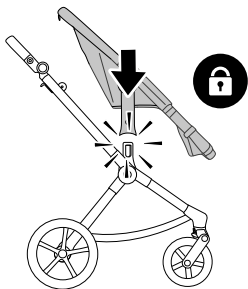

26

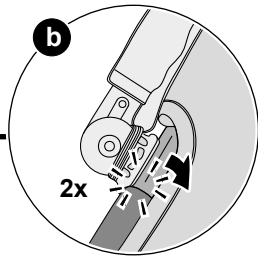
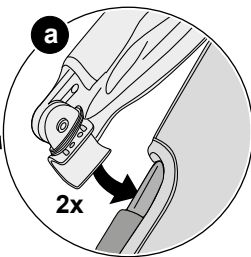
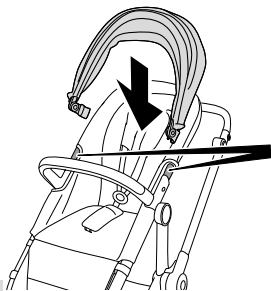

32

27

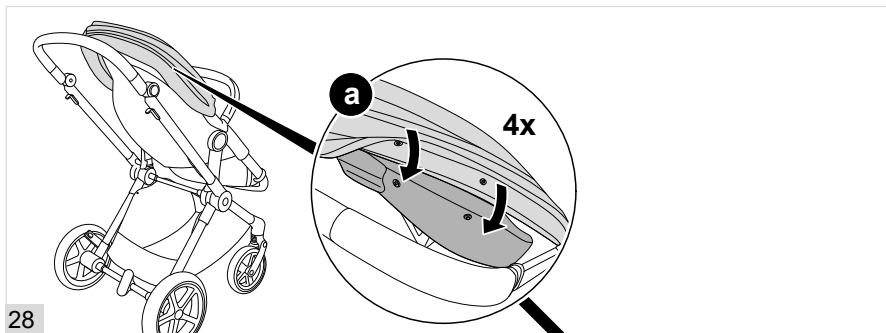

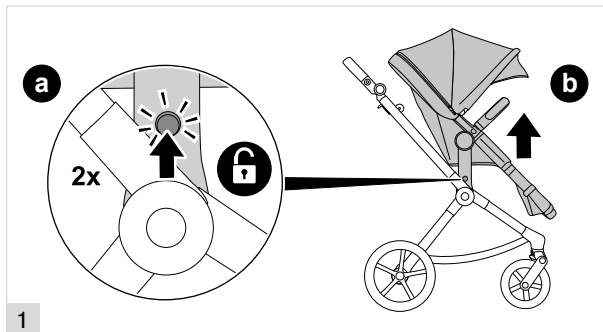
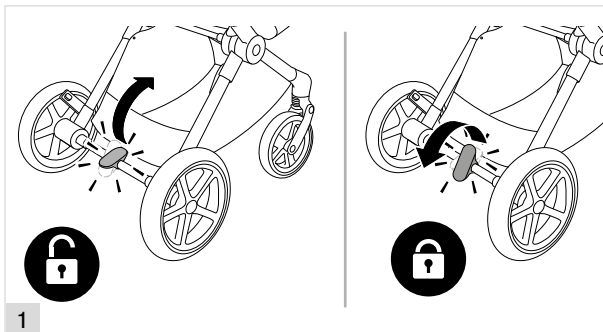

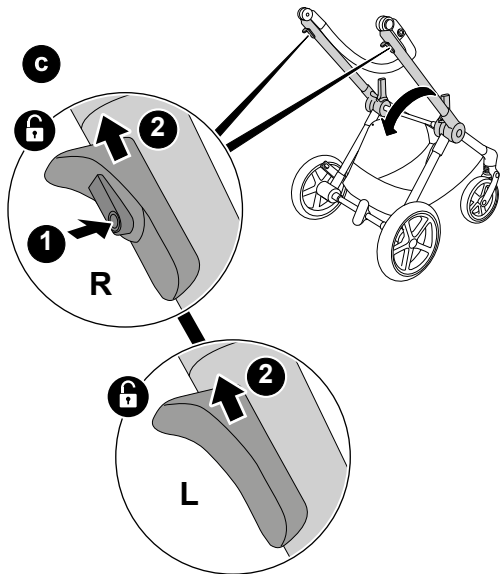
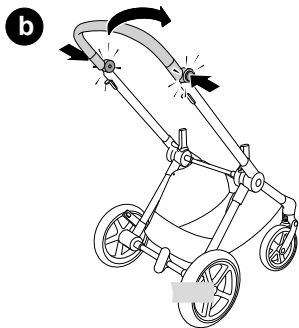



d

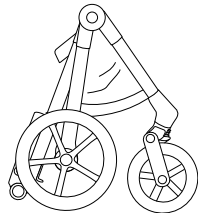
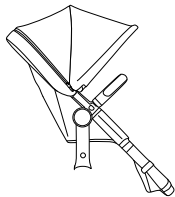
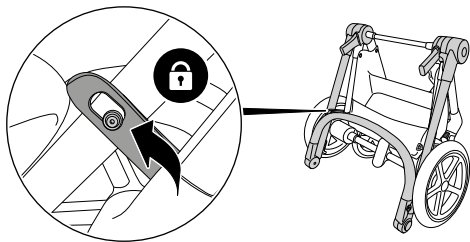

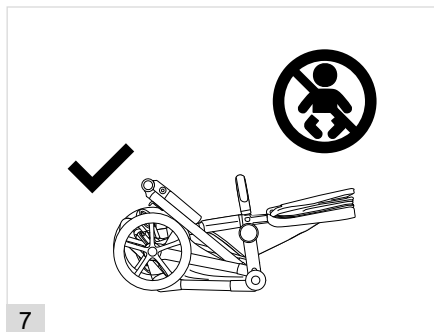
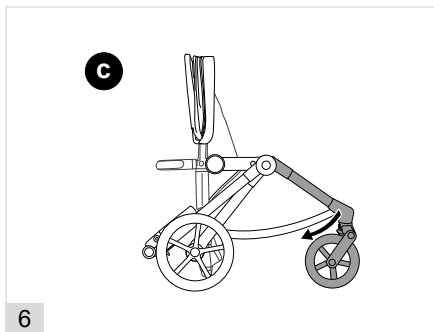
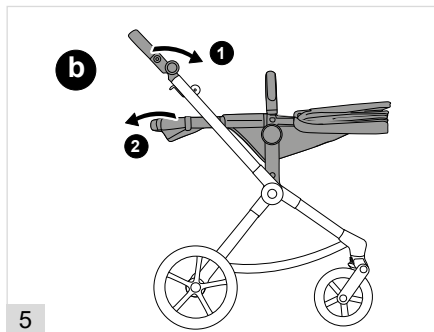
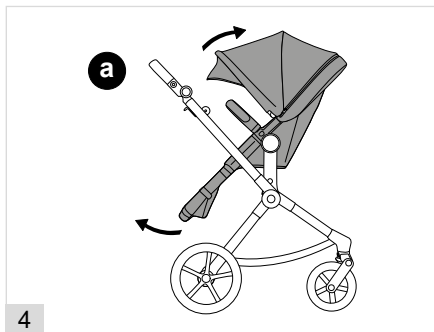



a

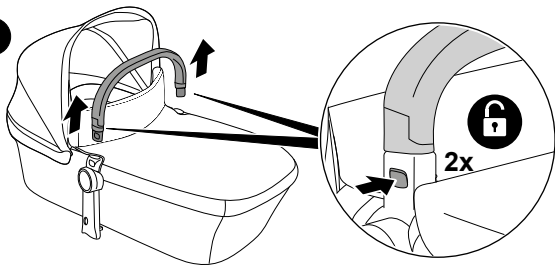

1

b

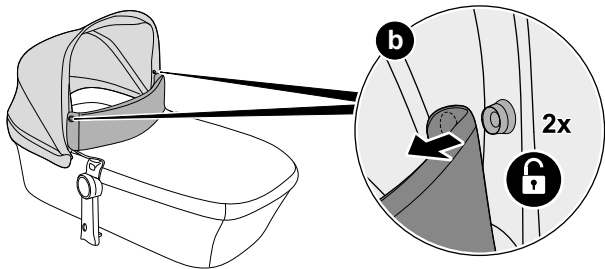

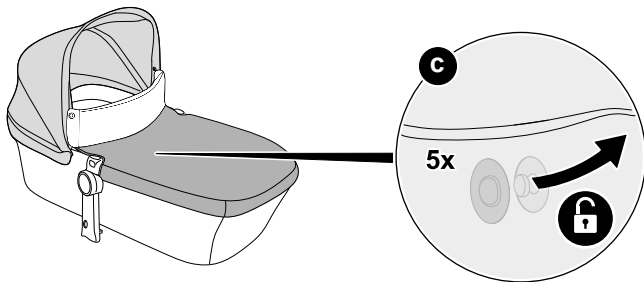

3

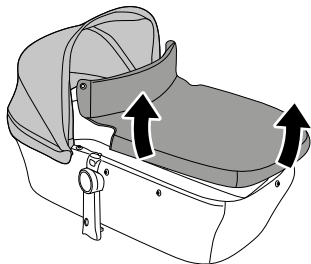

4

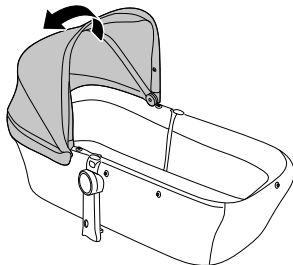

5



a

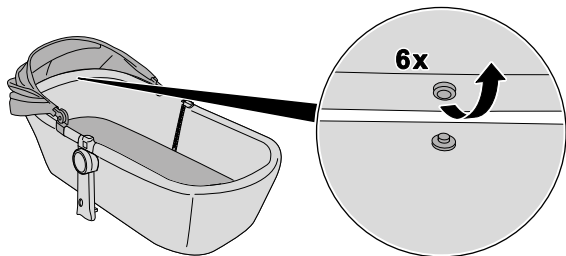

6

b

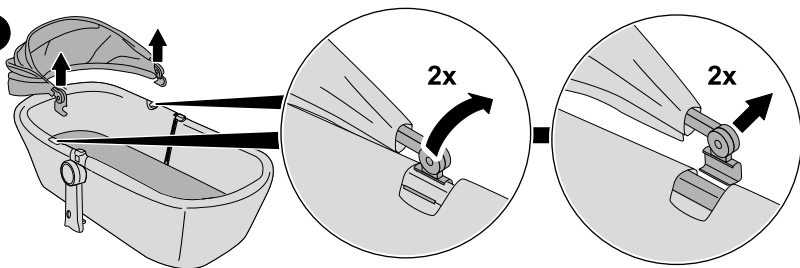

7

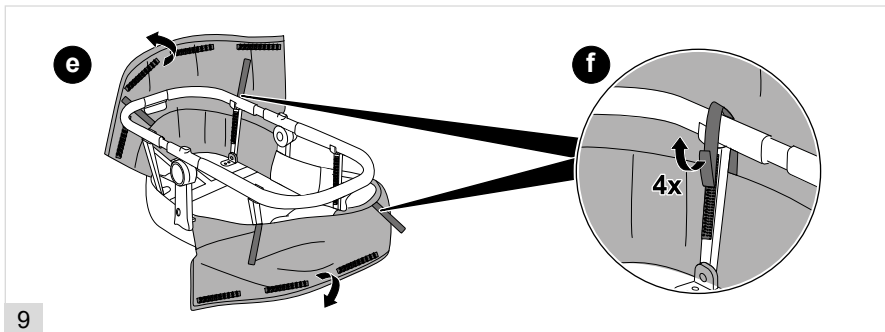
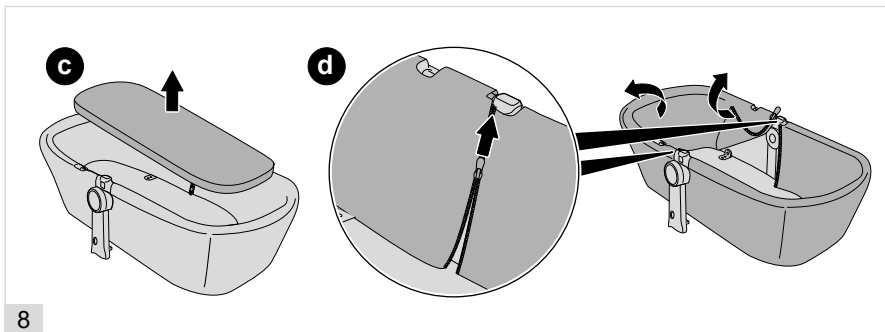

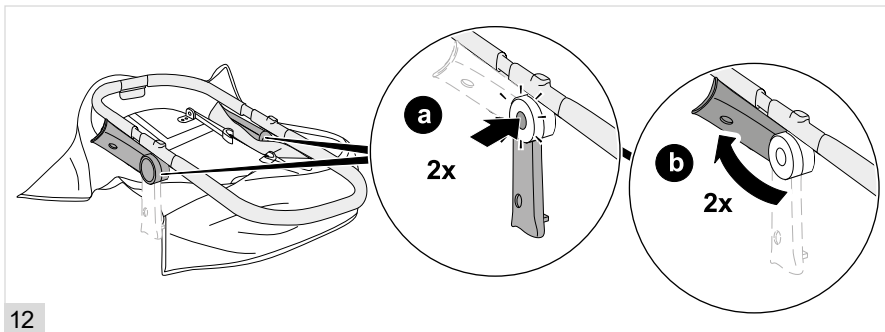
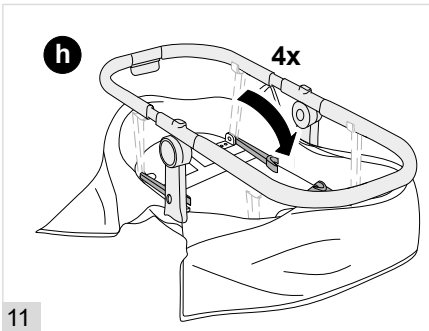
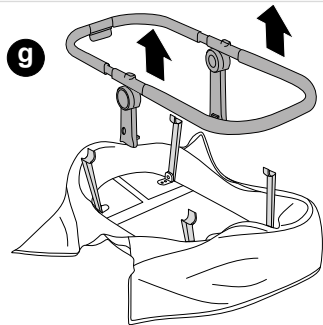

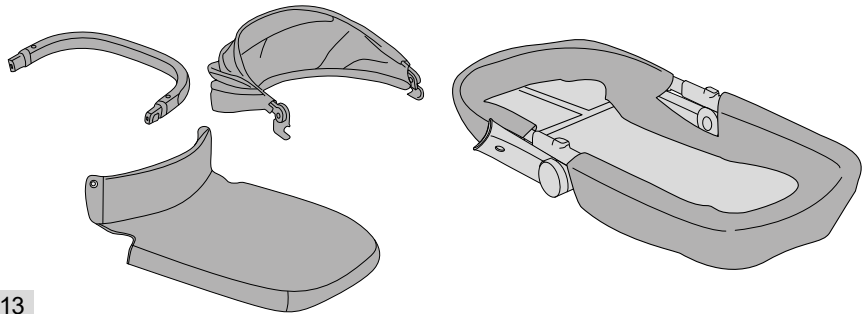

13



1

a

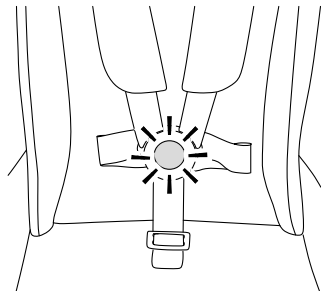

b

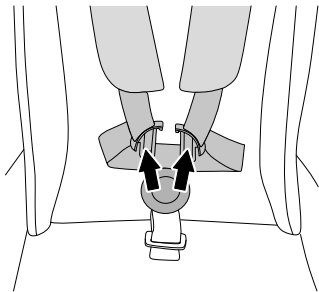

c

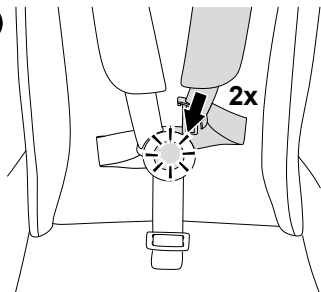



d

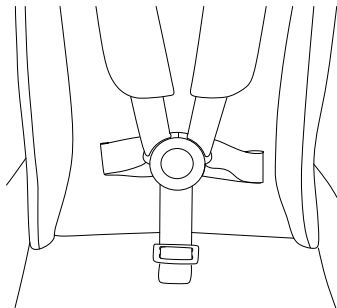

3

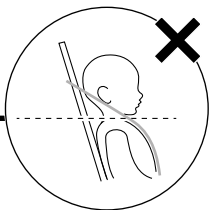
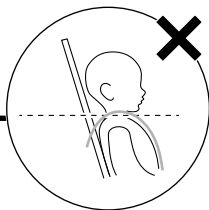
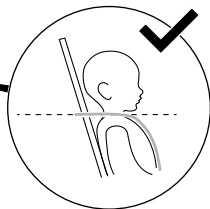
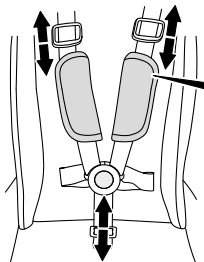

4

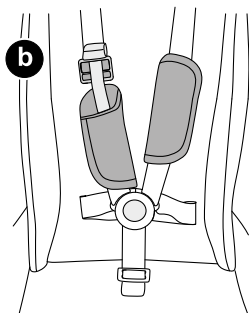
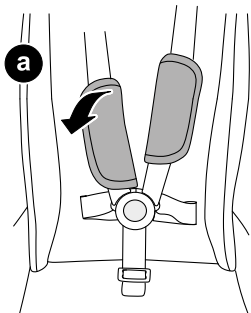

5

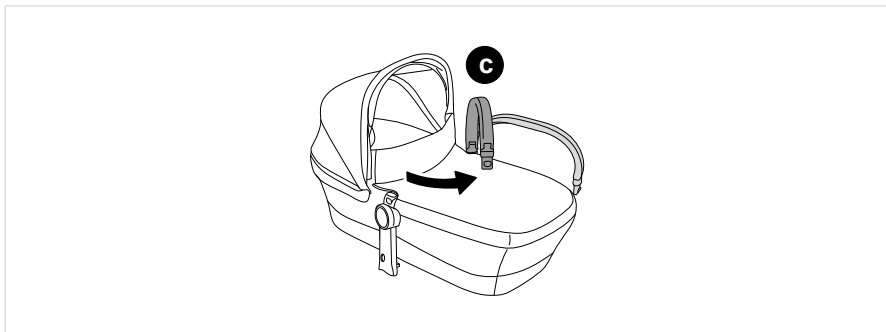
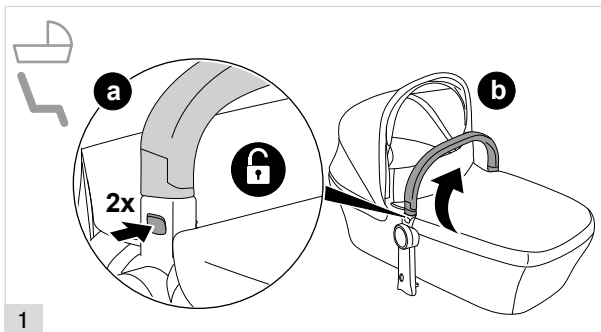

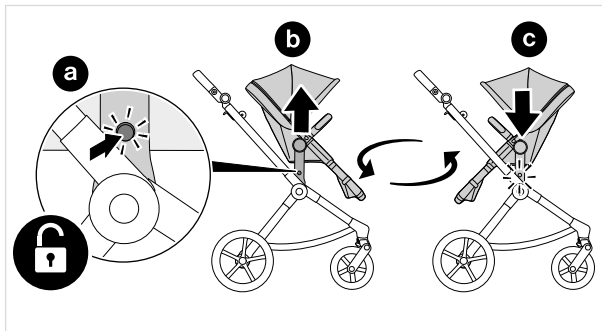

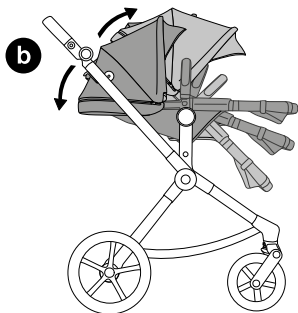
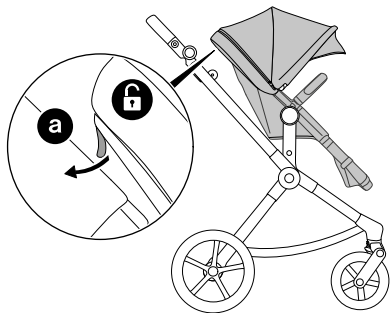

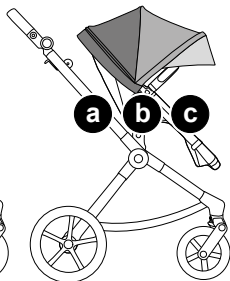
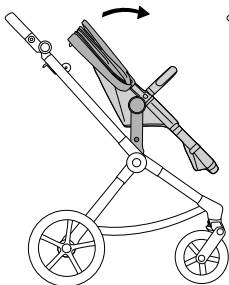

1

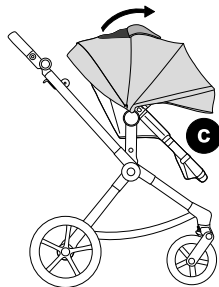
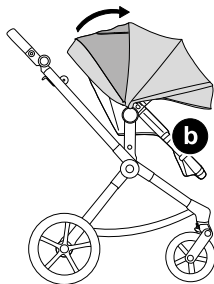
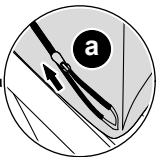

2

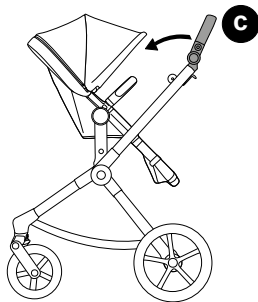
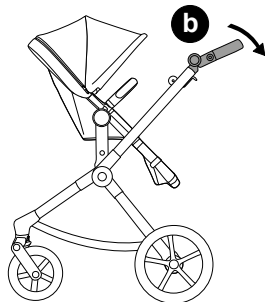
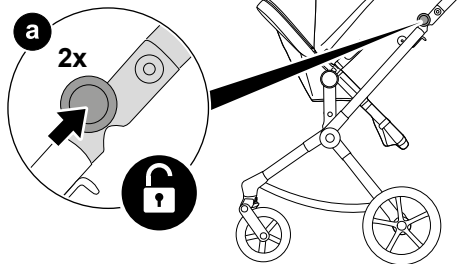



1

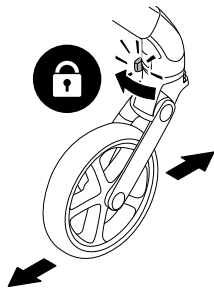
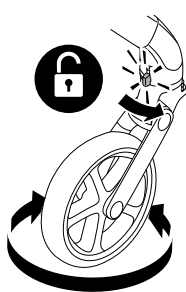

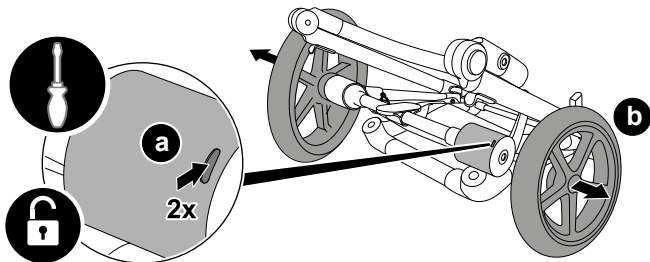
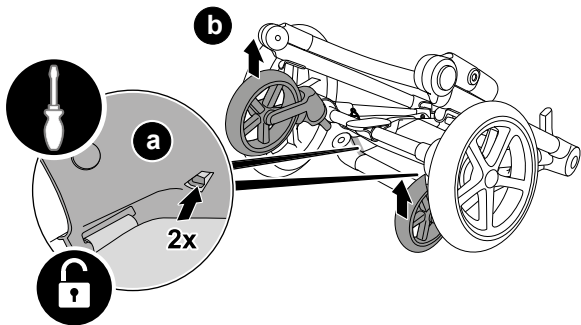

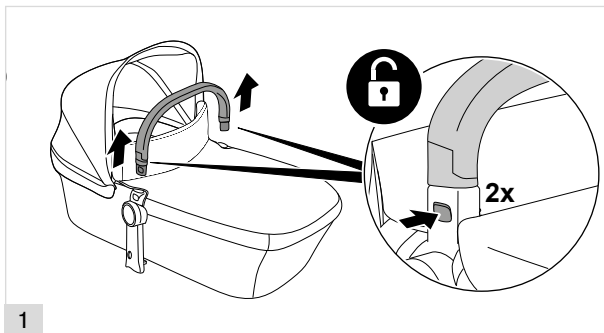

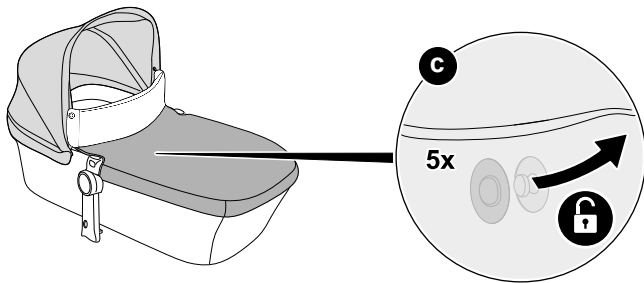
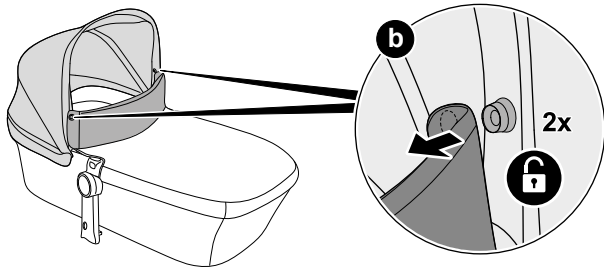

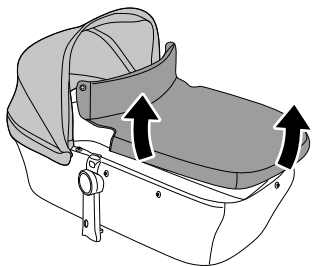

3

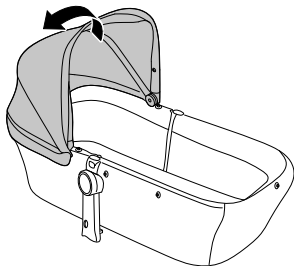

4

a

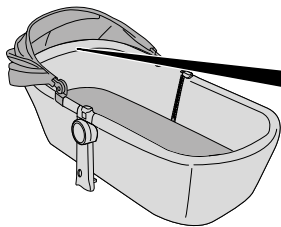

6x

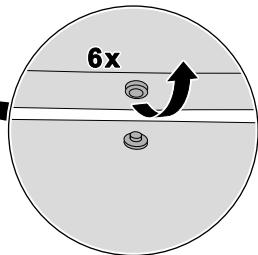

5

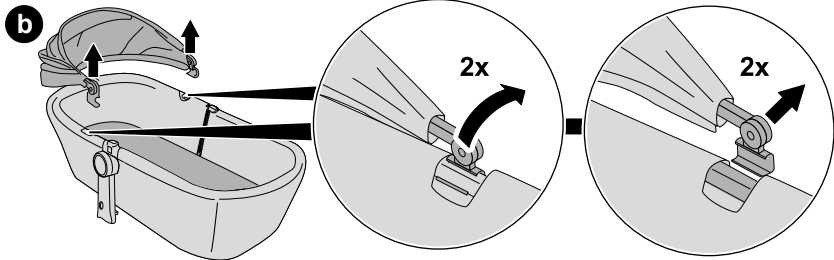

6

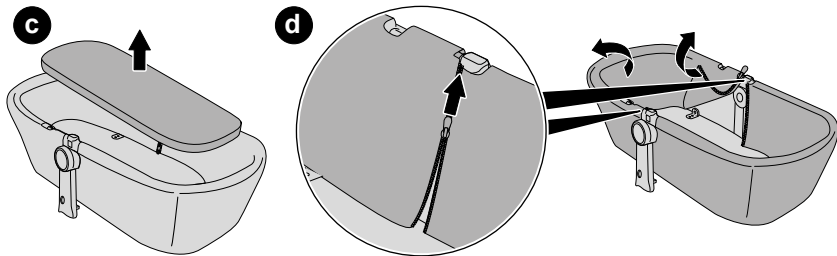

7

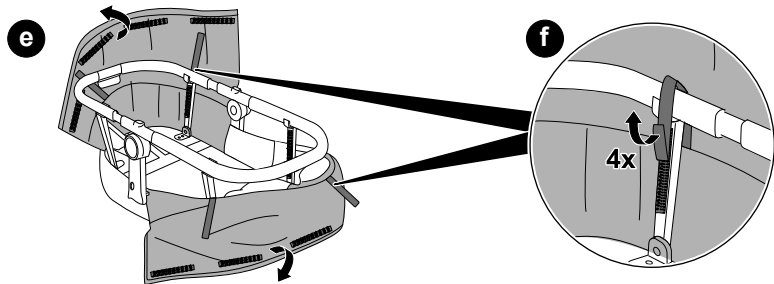

8

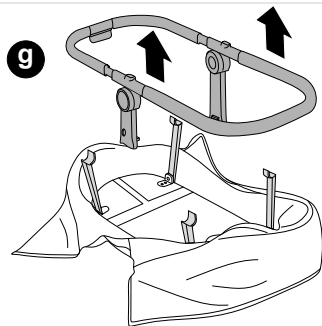

9

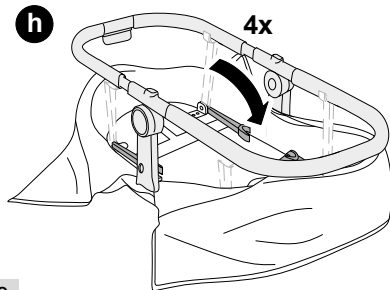

10

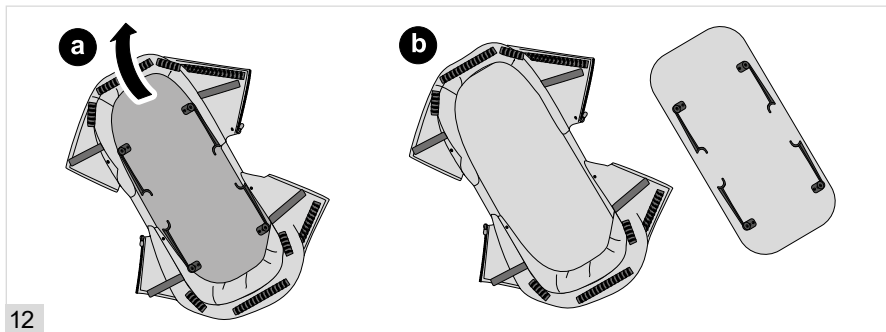
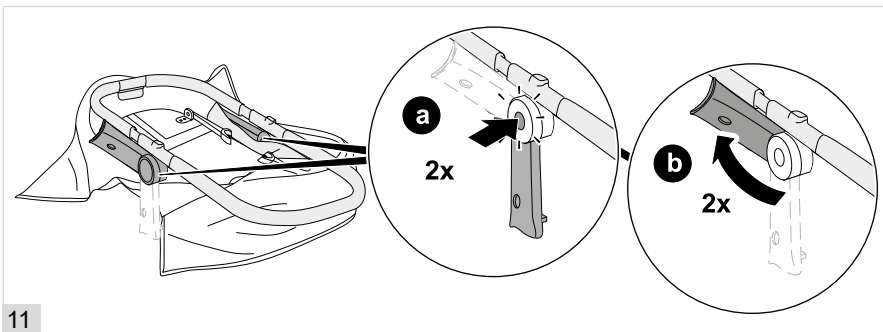

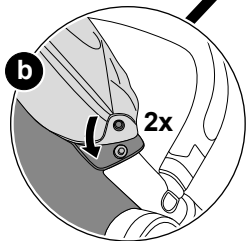
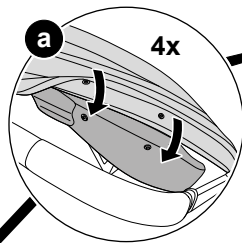

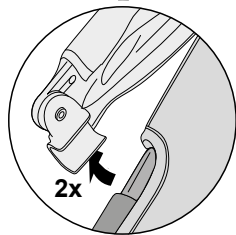
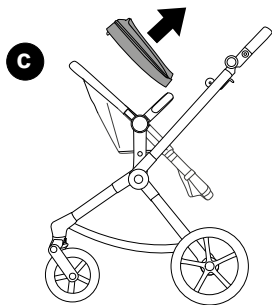
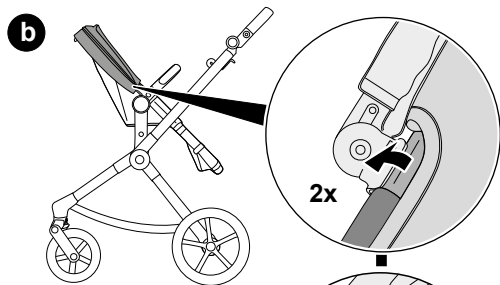
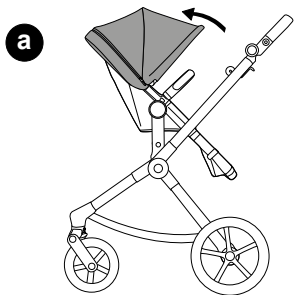



d

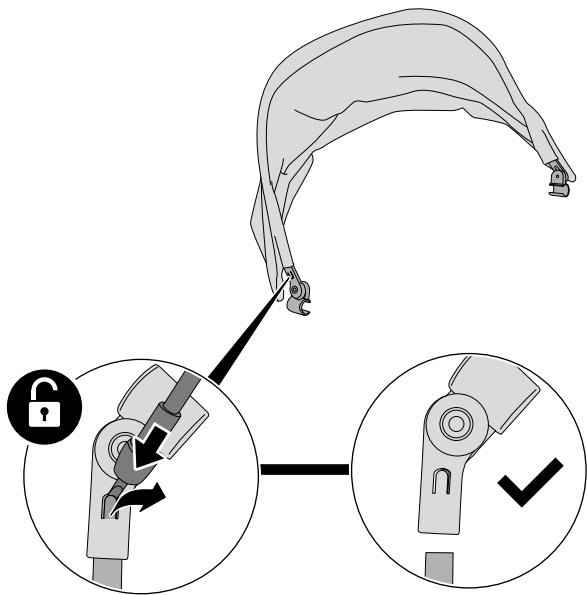

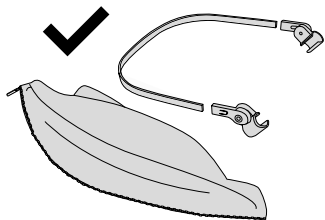
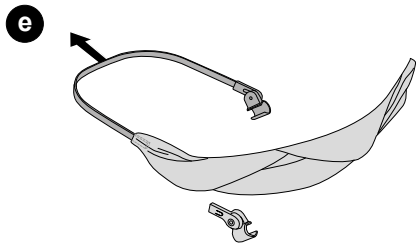

4

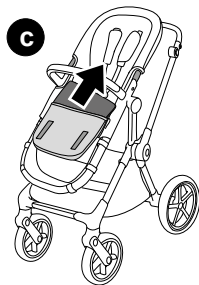
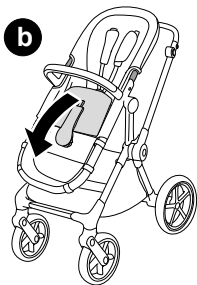
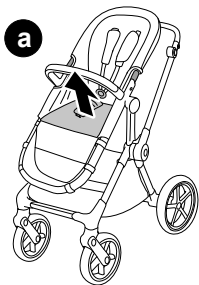

5

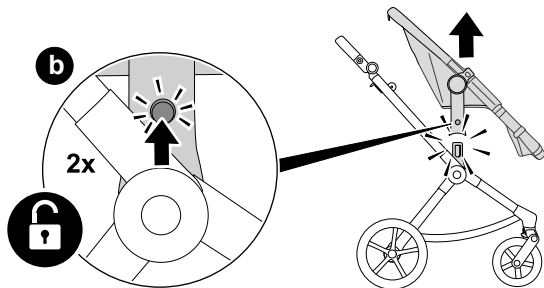
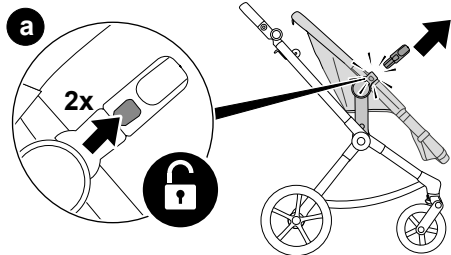

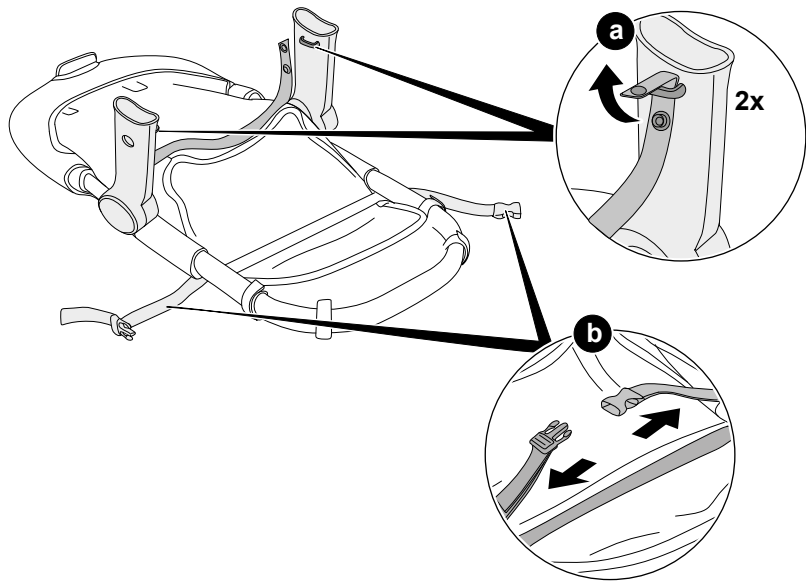

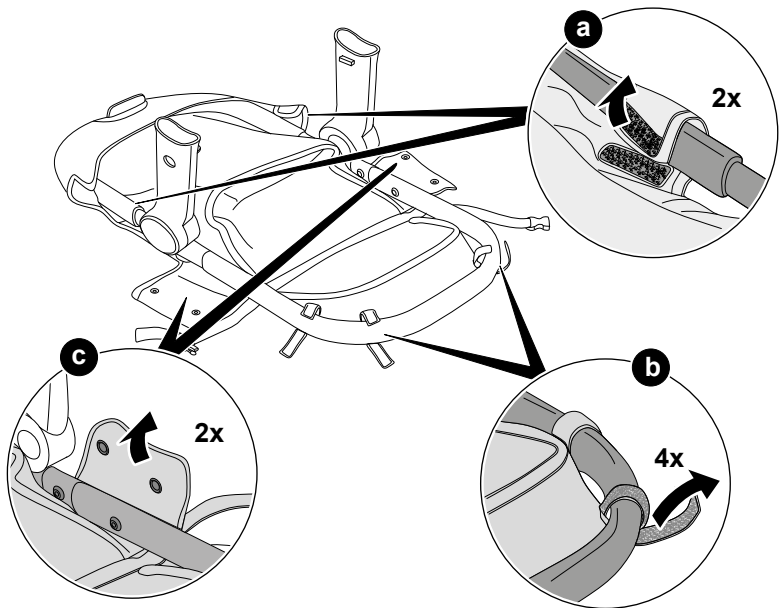

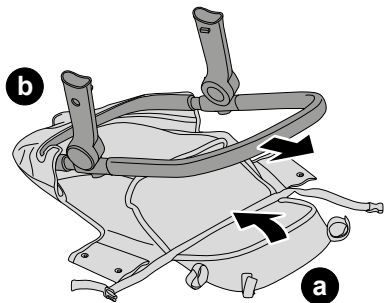

9

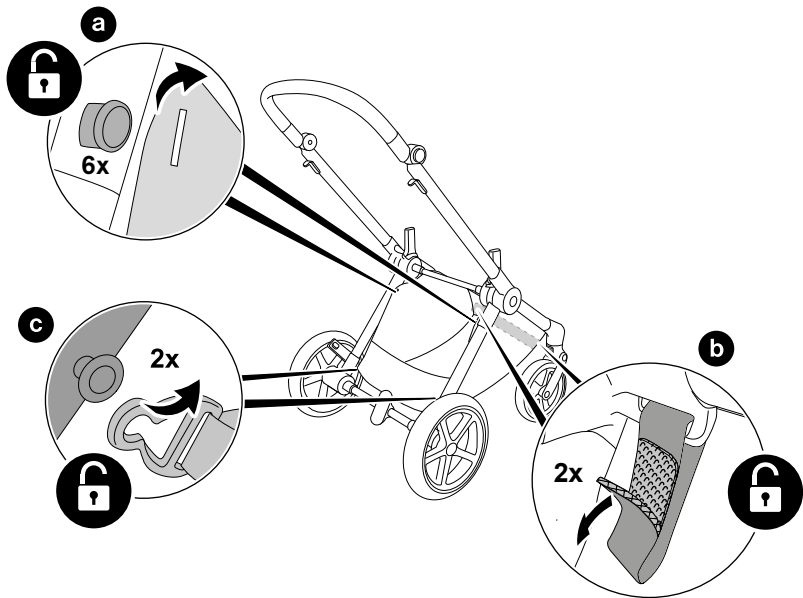

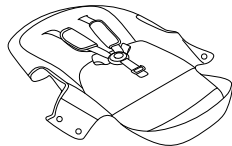
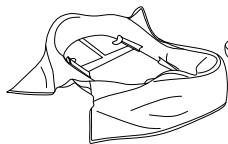
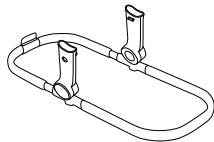
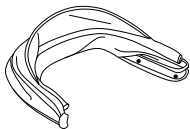
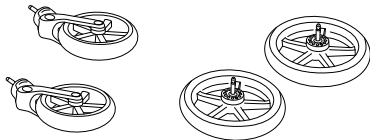
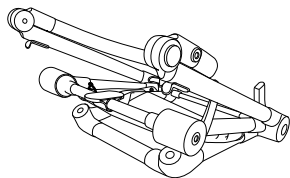

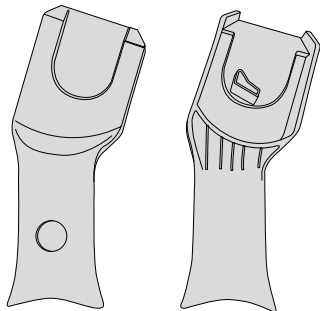

1

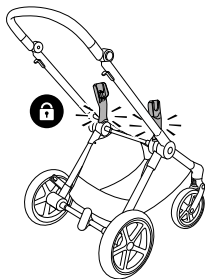
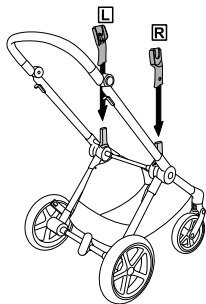

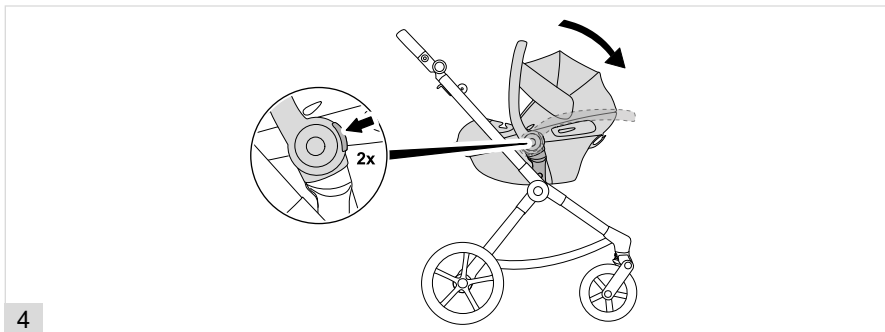

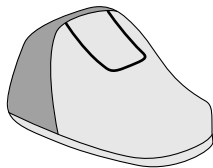

1

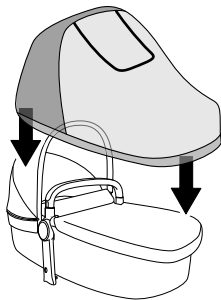

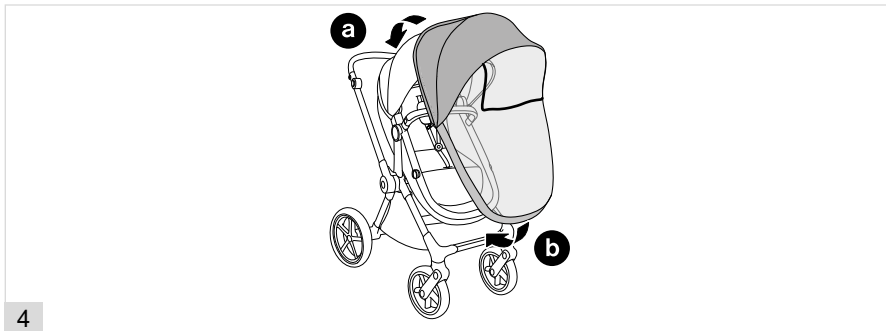
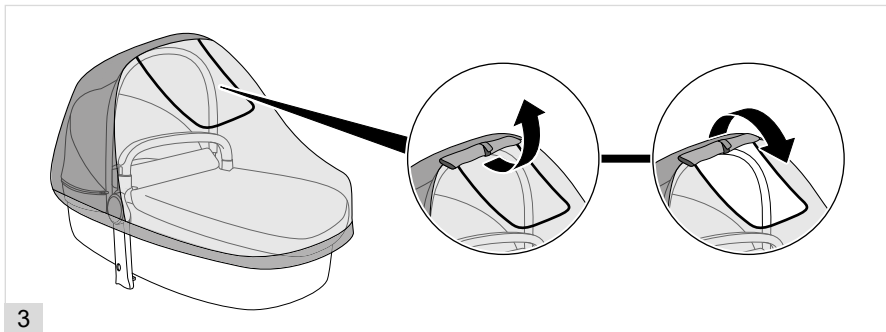

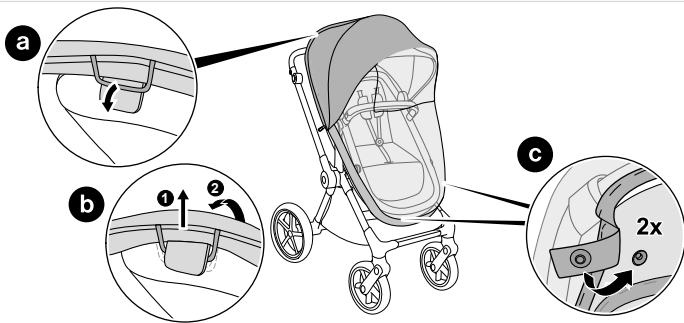



CYBEX GmbH
Riedingerstr. 18 | 95448 Bayreuth | Germany
+49 (0) 921-78 511-0 | info@cybex-online.com

www.cybex-online.com



Points de collecte sur www.quefairedemesdechets.fr