

anex[®]

MAINTENANCE MANUAL
INSTRUKCJA OBSŁUGI
PŘÍRUČKA ÚDRŽBY
BEDIENUNGSANLEITUNG
MANUAL DE MANTENIMIENTO
KASUTUSJUHEND
MANUEL D'ENTRETIEN
MANUALE DI MANUTENZIONE
სერვისის ინსტრუქცია
PRIEŽIŪROS INSTRUKCIJA
LIETOŠANAS INSTRUKCIJA
ONDERHOUDSHANDLEIDING
MANUAL DE MANUTENÇÃO
INSTRUCȚIUNI DE ÎNTREȚINERE
ИНСТРУКЦИЯ ОБСЛУЖИВАНИЯ
UNDERHÅLLSMANUAL
PRÍRUČKA ÚDRŽBY
KULLANIM KILAVUZU
ІНСТРУКЦІЯ ОБСЛУГОВУВАННЯ
РЪКОВОДСТВО ЗА ПОДДРЪЖКА

L/type

Unfolding the frame	5
Folding the frame	6
Folding the seat unit with frame	7
Unfolding the seat unit with frame	8
Handle adjustment	9
Assembly and disassembly of the rear/front wheels	10
Locking front swivel wheels	10
Brake	11
Connecting/disconnecting carrycot on the frame	11
Unfolding/folding of the carrycot	12
Carrycot ventilation	12
Carrycot hood adjustment	13
Carrycot cover	14
Connecting/disconnecting seat unit on the frame	14
Seat unit's hood adjustment	15
Seat unit ventilation	15
Seat unit's backrest adjustment	16
Footrest adjustment	16

Stroller's security barrier	17
Safety belts buckle	18
Safety belts length adjustment	18
Safety belts height adjustment	19
Assembly and disassembly of the shopping basket	19
Car seat	20
Seat unit cover	21
Universal mosquito net	21
Universal raincover	22
Carrycot's cleaning	22
Seat unit's cleaning	23

Unfolding the frame

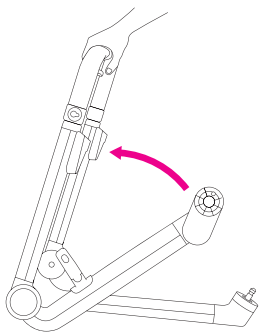
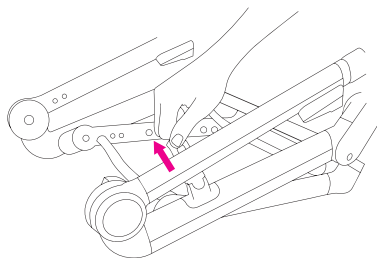
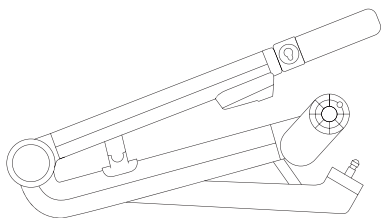

Folding the frame

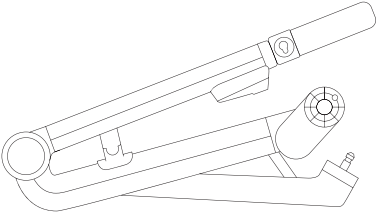
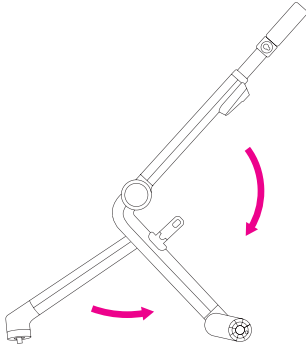
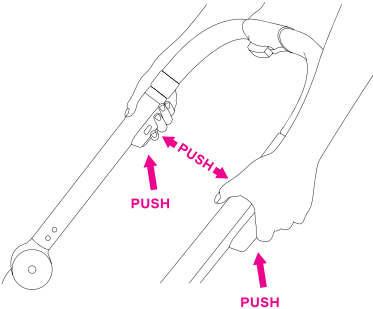

Folding the seat unit with frame

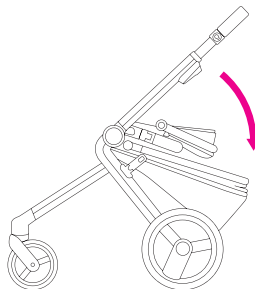
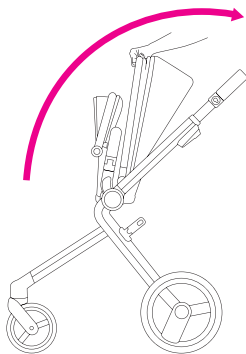
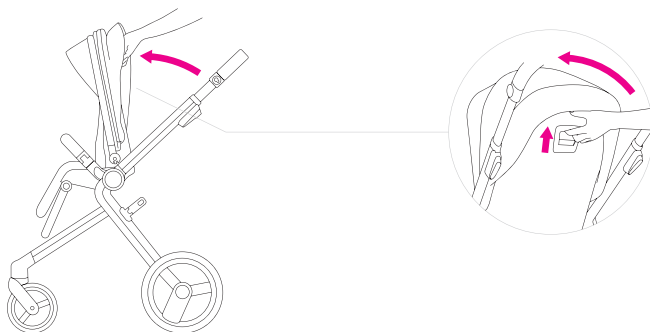

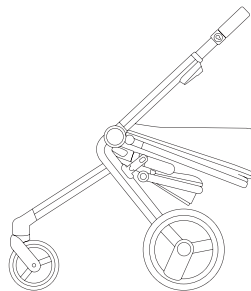
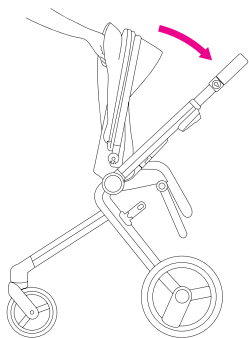

Unfolding the seat unit with frame

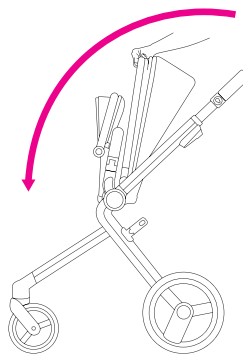
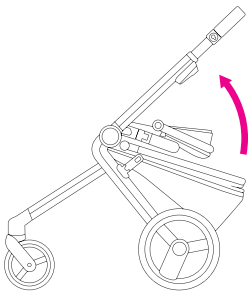

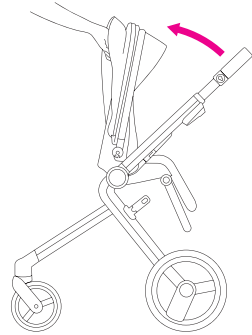
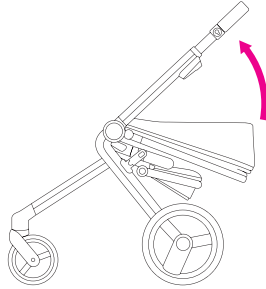
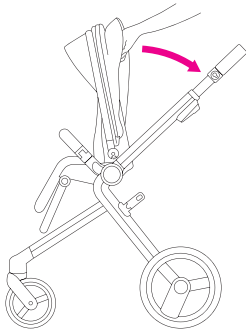

Handle adjustment

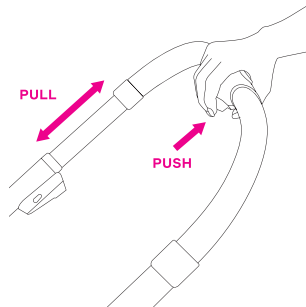

Assembly and disassembly of the rear/front wheels

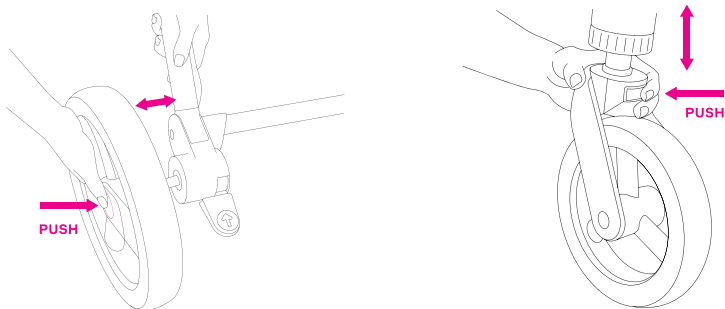

Locking front swivel wheels

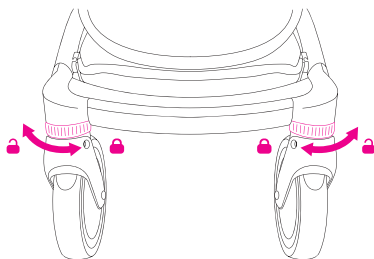

Brake

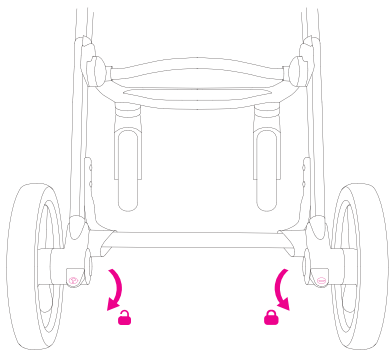

Connecting/disconnecting carrycot on the frame

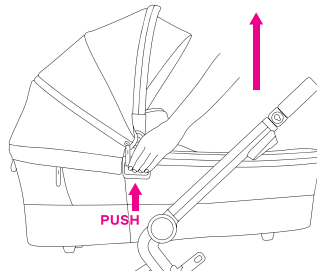
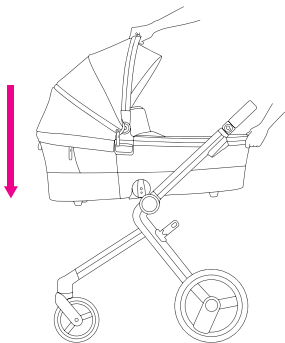

Unfolding/folding of the carrycot

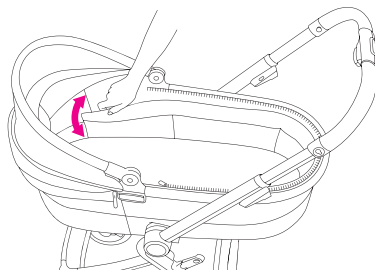
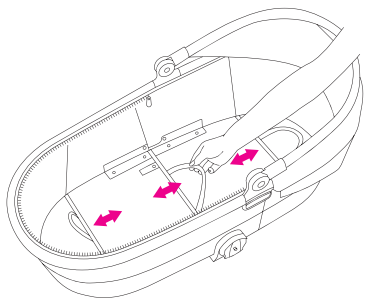

Carrycot ventilation

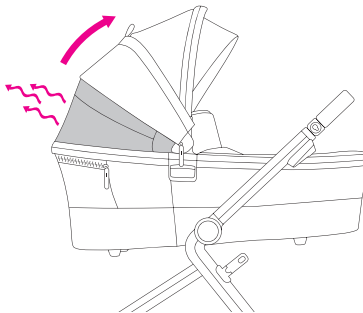
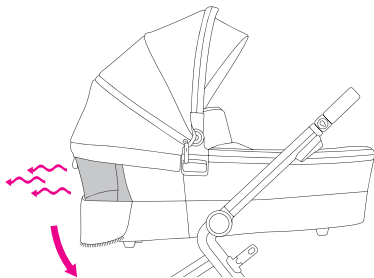

Carrycot hood adjustment

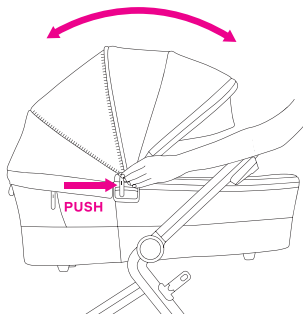
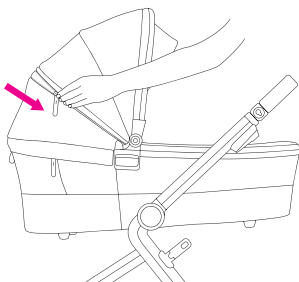
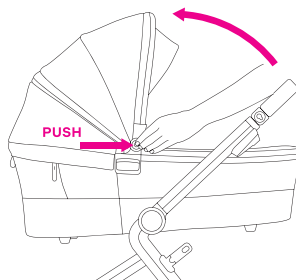
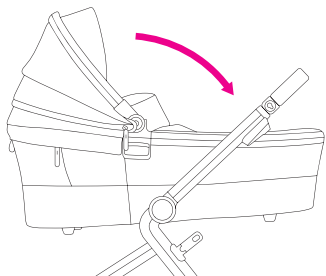

Carrycot cover

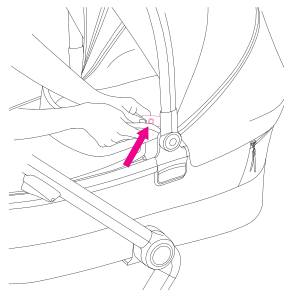
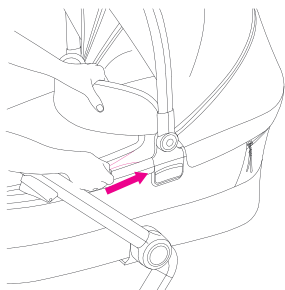

Connecting/disconnecting seat unit on the frame

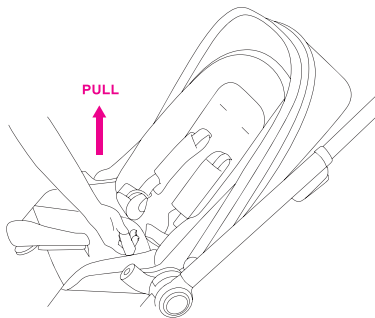
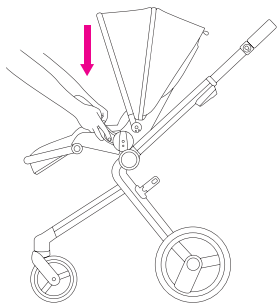

Seat unit's hood adjustment

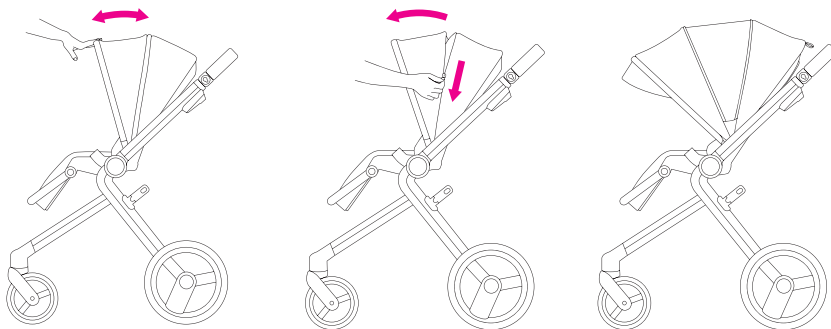

Seat unit ventilation

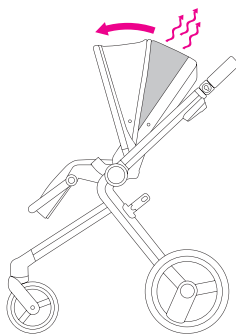

Seat unit's backrest adjustment

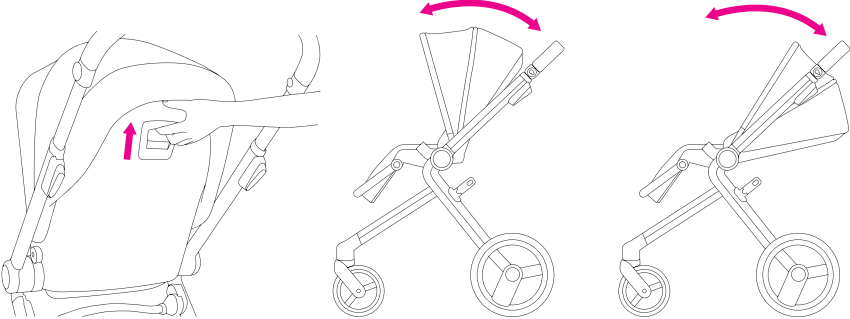

Footrest adjustment

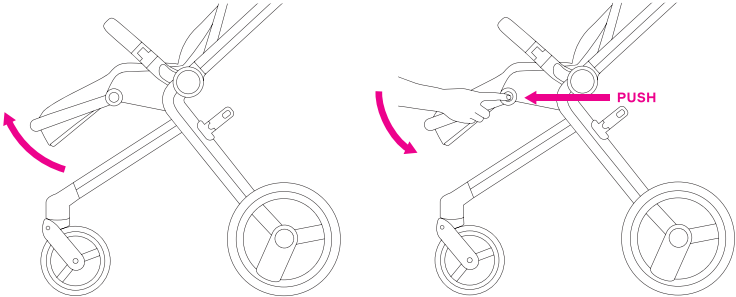

Stroller's security barrier

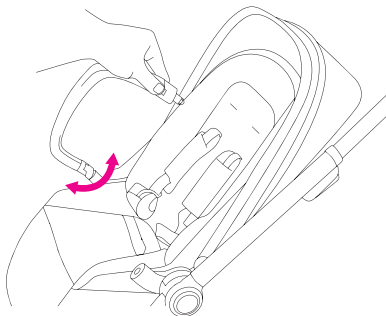
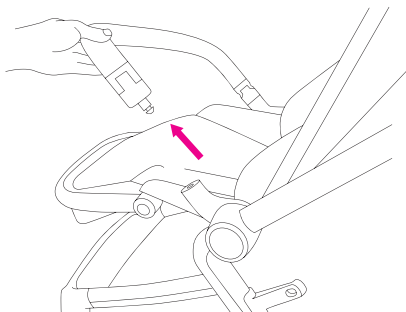
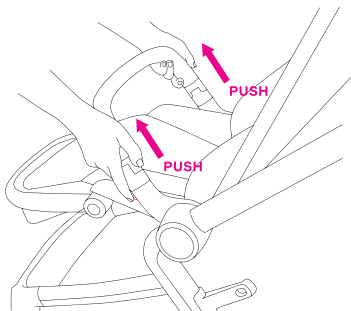
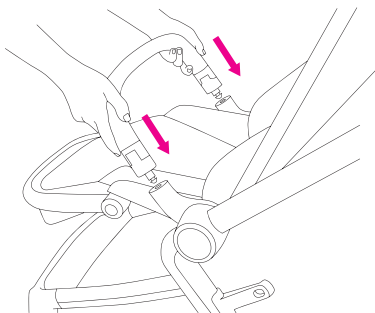

Safety belts buckle

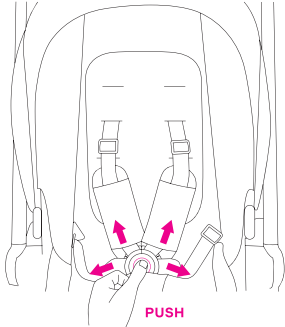
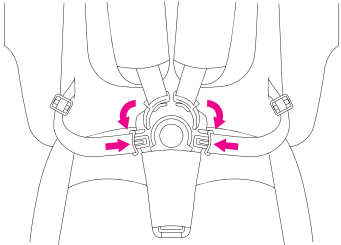

Safety belts length adjustment

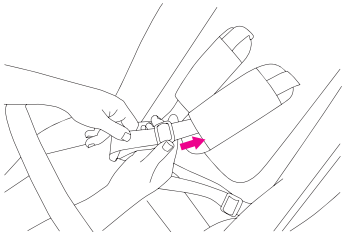

Safety belts height adjustment

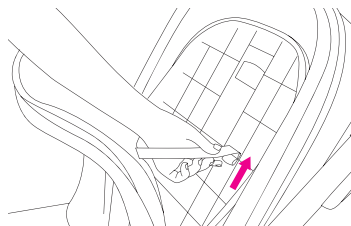
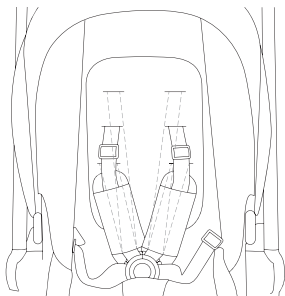

Assembly and disassembly of the shopping basket

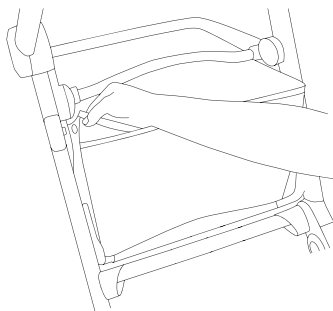
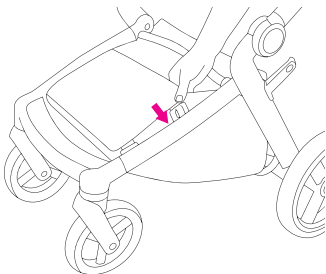

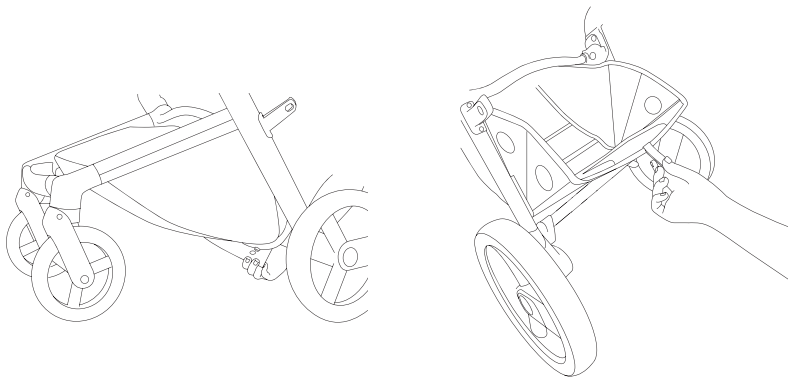

Car seat

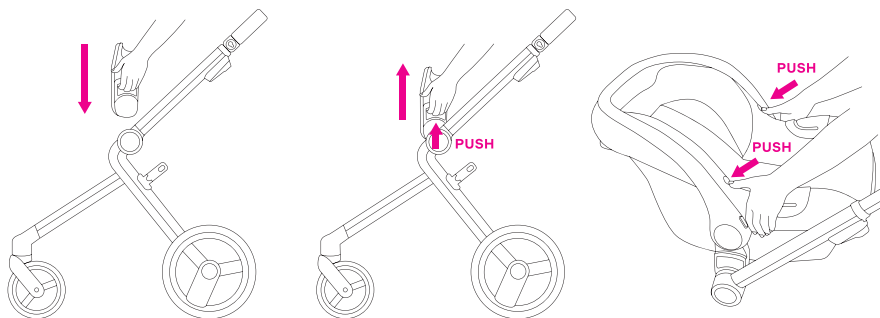

Seat unit cover

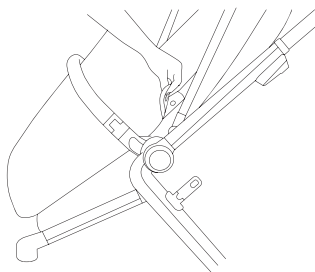

Universal mosquito net

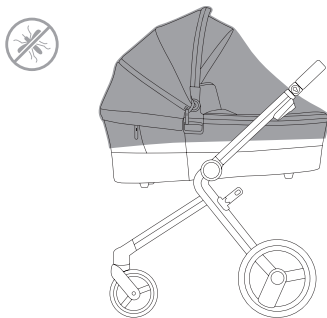

Universal raincover

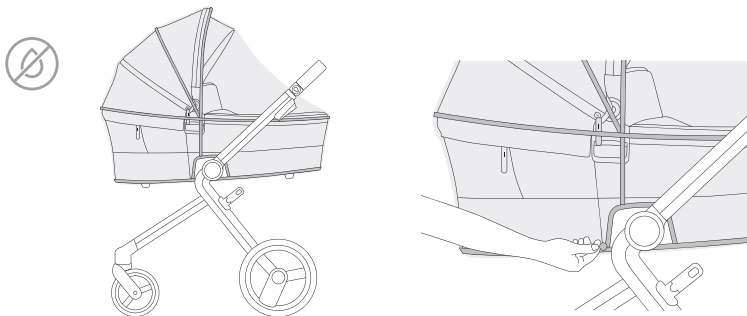

Cleaning carrycot

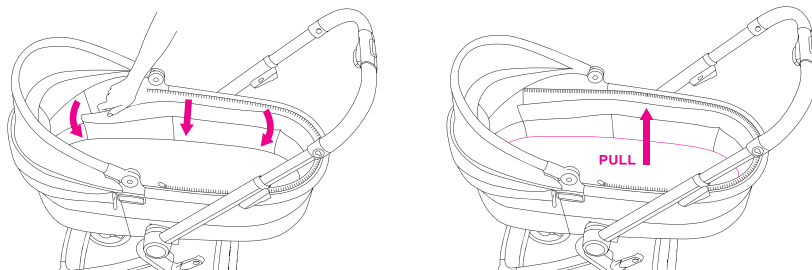

Cleaning seat unit

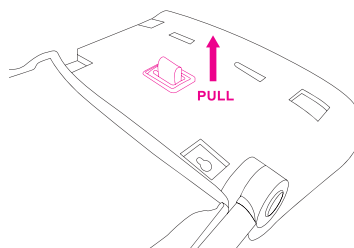
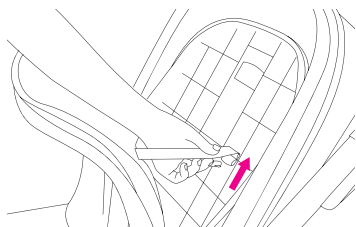
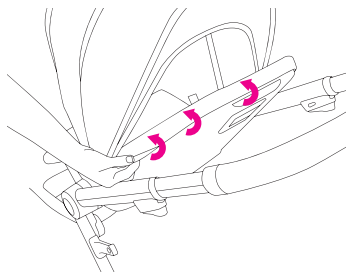
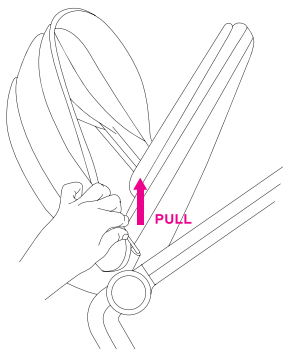

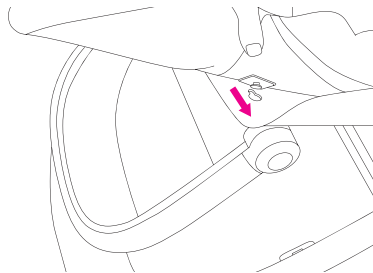
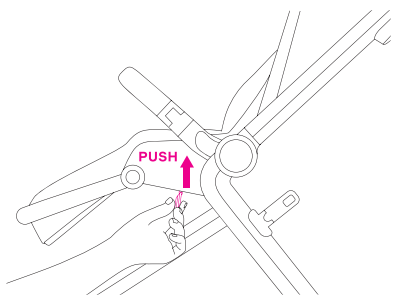

**Check for the most recent manuals
our website: anexbaby.com**

The information is subject to change without notice. Anex shall not be liable for technical errors or omissions contained in this manual. The purchased product may differ from the product as described in this manual.

Ideo Group LLC
Al. Solidarnosci 117
00-140 Warsaw, Poland
+48 22 211 67 08
office@anexbaby.com